

ABB solar inverters

Product manual
TRIO-20.0/27.6-TL-OUTD
(20.0 to 27.6 kW)





IMPORTANT SAFETY INSTRUCTIONS

This manual contains important safety instructions that must be followed during installation and maintenance of the equipment.



SAVE THESE INSTRUCTIONS!

This manual must be considered as an integral part of the equipment, and must be available at all times to everyone who interacts with the equipment.

The manual must always accompany the equipment, even when it is transferred to another user.



Operators are required to read this manual and scrupulously follow the indications reported in it, since ABB cannot be held responsible for damages caused to people and/or things, or the equipment, if the warranty conditions are not observed.

Product Manual

TRIO-20.0/27.6 string inverters

1 - Introduction and general information



2 - Characteristics



3 - Safety and accident prevention



4 - Lifting and transport



5 - Installation



6 - Instruments



7 - Operation



8 - Maintenance



Warranty and Supply Conditions

The warranty conditions are described in a special certificate supplied with the equipment. Furthermore, the warranty conditions are considered to be valid if the customer adheres to the indications in this manual; any conditions deviating from those described herein must be expressly agreed in the purchase order.

The equipment complies with the pertinent legislation currently in force in the country of installation and it has issued the corresponding declaration of conformity.

Not included in the supply



ABB accepts no liability for failure to comply with the instructions for correct installation and will not be held responsible for systems upstream or downstream the equipment it has supplied. It is absolutely forbidden to modify the equipment. Any modification, manipulation, or alteration not expressly agreed with the manufacturer, concerning either hardware or software, shall result in the immediate cancellation of the warranty.

The Customer is fully liable for any modifications made to the system.

Given the countless array of system configurations and installation environments possible, it is essential to check the following: sufficient space suitable for housing the equipment; airborne noise produced depending on the environment; potential flammability hazards.

ABB will NOT be held liable for defects or malfunctions arising from: improper use of the equipment; deterioration resulting from transportation or particular environmental conditions; performing maintenance incorrectly or not at all; tampering or unsafe repairs; use or installation by unqualified persons.

ABB will NOT be held responsible for the disposal of: displays, cables, batteries, accumulators etc. The Customer shall therefore arrange for the disposal of substances potentially harmful to the environment in accordance with the legislation in force in the country of installation.

Contents

Introduction and general information	4
Warranty and Supply Conditions	4
Not included in the supply.....	4
Contents	5
Reference number index	9
Graphical representation of references	9
The document and who it is for	10
Purpose and structure of the document	10
List of annexes	10
Staff characteristics.....	10
Symbols and signs	11
Field of use, general conditions	12
Intended or allowed use.....	12
Limits in field of use.....	12
Improper or prohibited use	12
Characteristics	13
General conditions	13
Models and range of equipment	14
Identification of the equipment and the manufacturer	15
Wiring Box components	17
Standard / -S2 Version.....	17
-S2X / -S2F Version	18
Principal wiring box components	19
Characteristics and technical data	20
Tightening torques	22
Overall dimensions	22
Bracket dimensions.....	23
Efficiency curves	24
Power derating	25
Derating due to environmental conditions	25
Derating due to the altitude of the installation	26
Derating due to the input voltage.....	26
Characteristics of a photovoltaic generator	28
Strings and Arrays.....	28
Description of the equipment	29
Operating diagram	29
Connection of several inverters together.....	30
Notes on the sizing of the system.....	30
Functionality and components of the equipment	31
Topographic diagram of the equipment	33
Protective devices	35
Anti-Islanding	35
Ground fault in the photovoltaic panels	35
String fuses	35
Overvoltage surge arresters	35
Further protective devices.....	35



Safety and accident prevention	36
Safety instructions and general information	36
Hazardous areas and operations	37
Environmental conditions and risks	37
Signs and Labels	37
Thermal hazard	38
Clothing and protective devices for staff.....	38
Residual risks	39
Table of residual risks	39
Lifting and transport	40
General conditions	40
Transport and handling	40
Lifting.....	40
Unpacking and checking	40
List of components supplied	41
Kit of recommended spare parts.....	42
Weight of the equipment units	42
Types of lifting	43
Installation	44
General conditions	44
Environmental checks.....	45
Installations above 2000 metres	45
Installation position.....	46
Operations preparatory to PV generator connection	50
Checking the correct polarity of the strings	50
Checking of leakage to ground of the photovoltaic generator.....	50
Choice of differential protection downstream of the inverter	50
Independent or parallel input channels configuration	52
Channel configuration examples	53
Configuration of independent channels (default configuration).....	54
Configuration of parallel-connected channels	54
Input connection to the PV generator (DC side)	55
Connection of inputs on the Standard and S2 models.....	55
Connection of inputs on the S2F / S2X model	56
Installation procedure for quick fit connectors	57
String protection fuses (-S2F / S2X models only)	59
Sizing of fuses.....	59
Grid output connection (AC side)	61
Characteristics and sizing of the protective earthing cable	61
Characteristics and sizing of the line cable	62
Load protection switch (AC disconnect switch).....	62
Connection to the AC side terminal board.....	63
Installation of the second protective earthing cable	64
Communication card	65
Connections to the communication card	66
Remote control connection	66
Connecting environmental sensors	67
Configurable Relay connection (ALARM).....	67
Specifications of environmental sensors	68
Connection diagrams for environmental sensors.....	69





5 V auxiliary output connection	69
Serial Communication Connection (RS485).....	70
Monitoring and control systems	72
Procedure for connection to a monitoring system	73
Monitoring system via Aurora Communicator.....	74
Monitoring system via PVI-DESKTOP (Cabled).....	74
Monitoring system via PVI-DESKTOP and PVI-RADIOMODULE	75
Monitoring system via PVI-AEC-EVO.....	75
Instruments.....	76
General conditions	76
Display and keyboard	77
Display fields and symbols description.....	77
Description of keyboard and LED Panel.....	78
Operation.....	79
General conditions	79
Monitoring and data transmission	80
User interface mode.....	80
Types of data available	80
Measurement tolerance	80
Preliminary operations before commissioning	81
Grid standard setting of the country and language display	81
Grid standard of the country and display language saving	82
Checking the polarity of the strings (models S2F and S2X only).....	83
“Strings self-test” procedure.....	83
Installing the Wiring Box cover.....	85
Commissioning.....	86
Display access and settings	88
Dynamic behaviour of the display.....	89
LED behaviour	90
Specifications on the behaviour of the LEDs.....	91
Insulation fault LED.....	91
Description of the menus	92
General information	92
Statistics menu.....	94
Settings menu	95
Info Menu	102
AUTOTEST procedure in accordance with standard CEI 0-21.....	103
Running the tests from the display menu	103
Turning off the inverter	105
Standard Wiring Box Version.....	105
Wiring Box Versions S2, S2F and S2X.....	106
Maintenance.....	107
General conditions	107
Routine maintenance	108
Troubleshooting	108
Alarm Messages	108
Power limitation messages	115
Dismantling the inverter	117
Dismantling the inverter	117
Dismantling the Wiring Box.....	118

Registration on “Registration” website and calculation of second-level password (Service Menu)	119
Resetting the time remaining to change the grid standard.....	122
Associating a “new component” after replacement	123
Replacing the string fuses (versions S2F / S2X)	124
Replacing the back-up battery	125
Verification of ground leakage	126
Behaviour of a system without leakage	126
Behaviour of a system with leakage	127
Measuring the insulation resistance of photovoltaic generator.....	128
Storage and dismantling	129
Storage of the equipment or prolonged stop	129
Dismantling, decommissioning and disposal.....	129
Further information	130
Contact us	131



Reference number index

- | | | |
|-----------------------|-----------------------------------|-----------------------------|
| 01 bracket | 10 service cable glands | 19 Input connectors (MPPT1) |
| 02 wiring box | 11 DC cable glands | 20 Input connectors (MPPT2) |
| 03 inverter | 12 jumpers | 21 anti-condensation valve |
| 04 cover | 13 DC input terminal board | 22 string fuses |
| 05 clamp screw | 14 AC+DC disconnect switch | 23 display |
| 06 handles | 15 DC overvoltage surge arresters | 24 keypad |
| 07 connector screws | 16 AC cable gland | 25 LED panel |
| 08 front cover | 17 AC output terminal board | 26 heatsink |
| 09 communication card | 18 AC overvoltage surge arresters | 27 locking screw |



Graphical representation of references

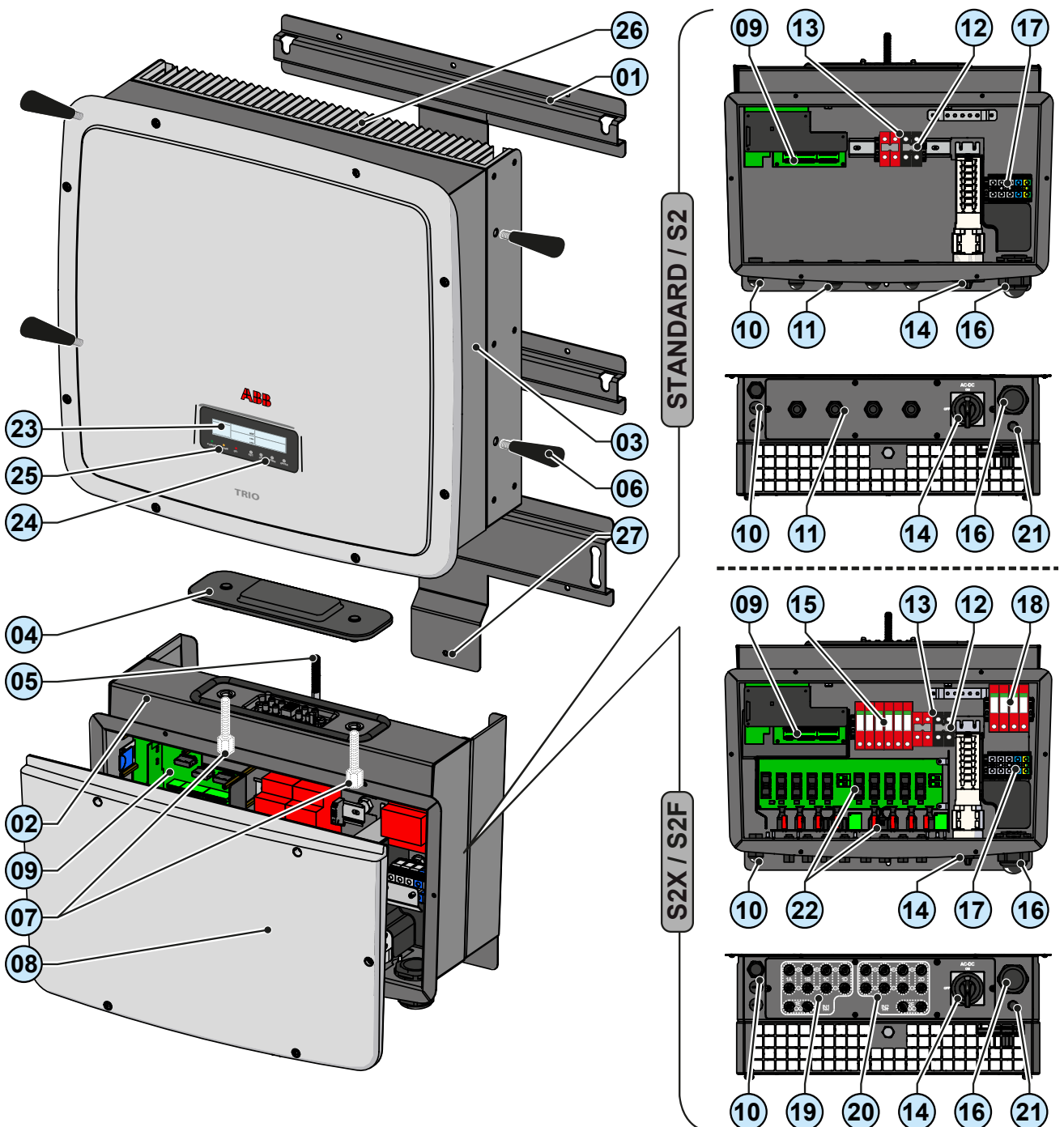

The document and who it is for

Purpose and structure of the document

This operating and maintenance manual is a useful guide that will enable you to work safely and carry out the operations necessary for keeping the equipment in good working order.



If the equipment is used in a manner not specified in the installer manual, the protection provided by the equipment may be impaired.



The language in which the document was originally written is ITALIAN; therefore, in the event of inconsistencies or doubts please ask the manufacturer for the original document.

List of annexes

In addition to this operating and maintenance manual, (if applicable or on request) the following enclosed documentation is supplied:

- EC declaration of conformity
- quick installation guide
- warranty



WARNING: Part of the information given in this document is taken from the original documents of the suppliers. This document contains only the information considered necessary for the use and routine maintenance of the equipment.

Staff characteristics



The customer must make sure that the operator has the necessary skill and training to do his/her job. Personnel in charge of using and maintaining the equipment must be expert, aware and skilled for the described tasks and must reliably demonstrate their capacity to correctly interpret what is described in the manual.



For safety reasons, only a qualified electrician who has received training and/or demonstrated skills and knowledge on the structure and operation of the unit may install the inverter.



The installation must be performed by qualified installers and/or licensed electricians in accordance with the existing regulations in the country of installation.



The employment of a person who is NOT qualified, is drunk, or on narcotics, is strictly forbidden.

















The customer has civil liability for the qualification and mental or physical state of the professional figures who interact with the equipment. They must always use the personal protective equipment required by the laws of the country of destination and whatever is provided by their employer.

Symbols ad signs

In the manual and/or in some cases on the equipment, the danger or hazard zones are indicated with signs, labels, symbols or icons.

Table: Symbols

	This points out that it is mandatory to consult the manual or original document, which must be available for future use and must not be damaged in any way.
	Generic hazard - Important safety information. This points out operations or situations in which staff must be very careful.
	Hazardous voltage - This points out operations or situations in which staff must be very careful due to hazardous voltage.
	Hot parts - This points out a hazard due to the presence of heated areas or in any case areas that have hot parts (danger of burns).
	This points out that the examined area must not be entered or that the described operation must not be carried out.
	This points out that it is mandatory to carry out the described operations using the clothing and/or personal protective equipment provided by the employer.
	This indicates the degree of protection of the equipment according to IEC standard 70-1 (EN 60529 June 1997).
	Point of connection for grounding protection.
	This indicates the allowed temperature range
	This indicates the risk of electric shock. Time need to discharge stored energy: 5/10 minutes
	Respectively direct current and alternating current
	Isolating transformer present or not present
	Positive pole and negative pole of the input voltage (DC)
	This indicates the centre of gravity of the equipment.



Field of use, general conditions

ABB shall not be liable for any damages whatsoever that may result from incorrect or careless operations.



*You may not use the equipment for a use that does not conform to that provided for in the field of use. The equipment **MUST NOT** be used by inexperienced staff, or even experienced staff if carrying out operations on the equipment that fail to comply with the indications in this manual and enclosed documentation.*

Intended or allowed use

This equipment is a inverter designed for:
transforming a continuous electrical current (DC)
supplied by a photovoltaic generator (FV)
in an alternating electrical current (AC)
suitable for feeding into the public distribution grid.

Limits in field of use

The inverter can be used only with photovoltaic modules which have ground isolated input poles, unless they are accessories installed that enable earthing of the inputs. In this case you must install an insulating transformer on the AC side of the system.

Only a photovoltaic generator can be connected in the input of the inverter (do not connect batteries or other sources of power supply).

The inverter can be connected to the electricity grid only in countries for which it has been certified/approved.

The inverter cannot be connected to the DC side in parallel to other inverters to convert energy from a photovoltaic generator with a power greater than the nominal power of the single inverter.

The inverter may only be used in compliance with all its technical characteristics.

Improper or prohibited use



IT IS STRICTLY FORBIDDEN TO:

- *Install the equipment in environments subject to particular conditions of flammability or in adverse or disallowed environmental conditions, (temperature and humidity).*
- *Use the equipment with safety devices which are faulty or disabled.*
- *Use the equipment or parts of the equipment by linking it to other machines or equipment, unless expressly provided for.*
- *Modify operating parameters that are not accessible to the operator and/or parts of the equipment to vary its performance or change its isolation.*
- *Clean with corrosive products that could eat into parts of the equipment or generate electrostatic charges.*
- *Use or install the appliance or parts of it without having read and understood the contents of the user and maintenance manual.*
- *Heat or dry rags and clothing on the parts in temperature. In addition to being hazardous, doing so would compromise component ventilation and cooling.*



General conditions

A description of the characteristics of the equipment is given so as to identify its main components and specify the technical terminology used in the manual.

Technical terminology and the fast retrieval system for information, are supported by:

- Contents
- Reference number index

The Characteristics chapter contains information about the models, details of the equipment, characteristics and technical data, overall dimensions and identification of the equipment itself.



The customer/Installer takes full responsibility if, when reading this manual, the chronological order of its presentation established by the manufacturer is not observed. All information is provided considering occasional inclusion of that provided in previous chapters.



In certain cases, there may be a need to separately document software functionality or attach supplementary documentation to this manual intended for more qualified professionals.

Models and range of equipment

The specific models of three-phase inverters that this manual is about are divided into two groups according to the maximum output power: 20kW or 27.6 kW.

For inverters of equal output power, the variant between the various models is the layout of the wiring box ②.



The choice of model of inverter must be made by a qualified technician who knows about the installation conditions, the devices that will be installed outside the inverter and possible integration with an existing system.

• 20.0kW three-phase MODELS	• 27.6 kW three-phase MODELS
TRIO-20.0-TL-OUTD-400: <ul style="list-style-type: none"> Nominal output power: 20.0kW Number of input channels: 2 Input connectors: screw terminal block ⑬ AC+DC Disconnect switch ⑭: No DC overvoltage surge arresters ⑮: No AC overvoltage surge arresters ⑱: No String protection fuses ⑳ No 	TRIO-27.6-TL-OUTD-400: <ul style="list-style-type: none"> Nominal output power: 27.6kW Number of input channels: 2 Input connectors: screw terminal block ⑬ AC+DC Disconnect switch ⑭: No DC overvoltage surge arresters ⑮: No AC overvoltage surge arresters ⑱: No String protection fuses ⑳ No
TRIO-20.0-TL-OUTD-S2-400: <ul style="list-style-type: none"> Nominal output power: 20.0kW Number of input channels: 2 Input connectors: screw terminal block ⑬ AC+DC Disconnect switch ⑭: Yes DC overvoltage surge arresters ⑮: No AC overvoltage surge arresters ⑱: No String protection fuses ⑳ No 	TRIO-27.6-TL-OUTD-S2-400: <ul style="list-style-type: none"> Nominal output power: 27.6kW Number of input channels: 2 Input connectors: screw terminal block ⑬ AC+DC Disconnect switch ⑭: Yes DC overvoltage surge arresters ⑮: No AC overvoltage surge arresters ⑱: No String protection fuses ⑳ No
TRIO-20.0-TL-OUTD-S2F-400: <ul style="list-style-type: none"> Nominal output power: 20.0kW Number of input channels: 2 Input connectors: quick fit connectors (4 pairs for each channel) AC+DC Disconnect switch ⑭: Yes DC overvoltage surge arresters ⑮: No AC overvoltage surge arresters ⑱: No String protection fuses ⑳ Yes 	TRIO-27.6-TL-OUTD-S2F-400: <ul style="list-style-type: none"> Nominal output power: 27.6kW Number of input channels: 2 Input connectors: quick fit connectors (5 pairs for each channel) AC+DC Disconnect switch ⑭: Yes DC overvoltage surge arresters ⑮: No AC overvoltage surge arresters ⑱: No String protection fuses ⑳ Yes
TRIO-20.0-TL-OUTD-S2X-400: <ul style="list-style-type: none"> Nominal output power: 20.0kW Number of input channels: 2 Input connectors: quick fit connectors (4 pairs for each channel) AC+DC Disconnect switch ⑭: Yes DC overvoltage surge arresters ⑮: Yes AC overvoltage surge arresters ⑱: Yes String protection fuses ⑳ Yes 	TRIO-27.6-TL-OUTD-S2X-400: <ul style="list-style-type: none"> Nominal output power: 27.6kW Number of input channels: 2 Input connectors: quick fit connectors (5 pairs for each channel) AC+DC Disconnect switch ⑭: Yes DC overvoltage surge arresters ⑮: Yes AC overvoltage surge arresters ⑱: Yes String protection fuses ⑳ Yes

Identification of the equipment and the manufacturer

The technical data shown in this manual do not in any case replace those shown on the labels attached to the equipment.



The labels attached to the equipment must NOT be removed, damaged, dirtied, hidden, etc.

The approval label contains the following information:

1. Manufacturer
2. Model
3. Rating data
4. Certification marks



N.B. The labels must NOT be hidden with objects and extraneous parts (rags, boxes, equipment, etc.); they must be cleaned regularly and kept visible at all times.

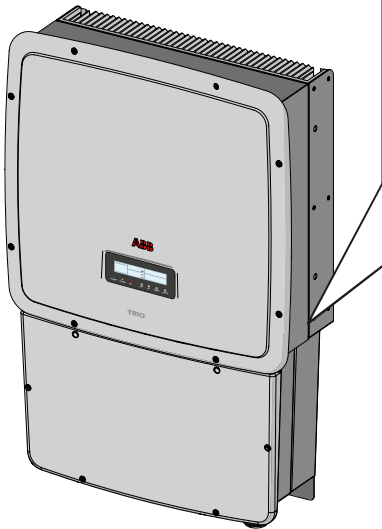

Model	V _{dc} max	V _{dc} MPP	V _{dc} Full Power	I _{dc} max	V _{acr}	f _r	P _{acr} (cos φ = 1)	P _{acr} (cos φ = ±0.9)	I _{sc} max
TRIO-20.0-TL-OUTD-400	1000 V	200 - 950 V	440 - 800 V	2 x 25 A	400 V 3Ø	50 Hz	20000 W @ 45 °C amb.	20000 W @ 45 °C amb.	33 A
TRIO-27.6-TL-OUTD-400	1000 V	200 - 950 V	500 - 800 V	2 x 32 A	400 V 3Ø	50 Hz	27600 W @ 45 °C amb.	27600 W @ 45 °C amb.	45 A
TRIO-20.0-TL-OUTD-S2-400	1000 V	200 - 950 V	440 - 800 V	2 x 25 A	400 V 3Ø	50 Hz	20000 W @ 45 °C amb.	20000 W @ 45 °C amb.	33 A
TRIO-27.6-TL-OUTD-S2-400	1000 V	200 - 950 V	500 - 800 V	2 x 32 A	400 V 3Ø	50 Hz	27600 W @ 45 °C amb.	27600 W @ 45 °C amb.	45 A
TRIO-20.0-TL-OUTD-S2F-400	1000 V	200 - 950 V	440 - 800 V	2 x 25 A	400 V 3Ø	50 Hz	20000 W @ 45 °C amb.	20000 W @ 45 °C amb.	33 A
TRIO-27.6-TL-OUTD-S2F-400	1000 V	200 - 950 V	500 - 800 V	2 x 32 A	400 V 3Ø	50 Hz	27600 W @ 45 °C amb.	27600 W @ 45 °C amb.	45 A
TRIO-20.0-TL-OUTD-S2X-400	1000 V	200 - 950 V	440 - 800 V	2 x 25 A	400 V 3Ø	50 Hz	20000 W @ 45 °C amb.	20000 W @ 45 °C amb.	33 A
TRIO-27.6-TL-OUTD-S2X-400	1000 V	200 - 950 V	500 - 800 V	2 x 40 A	400 V 3Ø	50 Hz	27600 W @ 45 °C amb.	27600 W @ 45 °C amb.	45 A

In addition to the label showing the specifications of the inverter, there are two part identification labels for the inverter and wiring box. These labels list the following information:

<p>TRIO-XX.X-TL-OUTD-Y-400</p>  <p>P/N: P/P/P/P/P/P/P/P/P/P</p> <p>SN: YYWWSSSSSS WK: WWYY</p> <p>WO: XXXXXXXX</p> <p>SO: SXXXXXXXX Q1</p>	<ul style="list-style-type: none"> • Inverter model <ul style="list-style-type: none"> - XX.X = Inverter power rating: - Y = Wiring box model • Inverter Part Number • Week/Year of manufacture • Inverter Serial Number composed of: <ul style="list-style-type: none"> - YY = Year of manufacture - WW = Week of manufacture - SSSSSS = sequential number
--	--



The officially required information is located on the approval label. The identification label is an accessory label which shows the information necessary for the identification and characterisation of the inverter by ABB.



If the service password is required, please use the details shown on the top label (inverter)



N.B. The labels must NOT be hidden with objects and extraneous parts (rags, boxes, equipment, etc.); they must be cleaned regularly and kept visible at all times.

Wiring Box components

For both models of inverter ⑨ (20 kW or 27.6 kW), three wiring box ② are available with different layouts.

Standard / -S2 Version

TRIO-XX.X-TL-OUTD: Standard version wiring box

TRIO-XX.X-TL-OUTD-S2: S2 wiring box version, like the basic version but with AC+DC disconnect switch ⑭

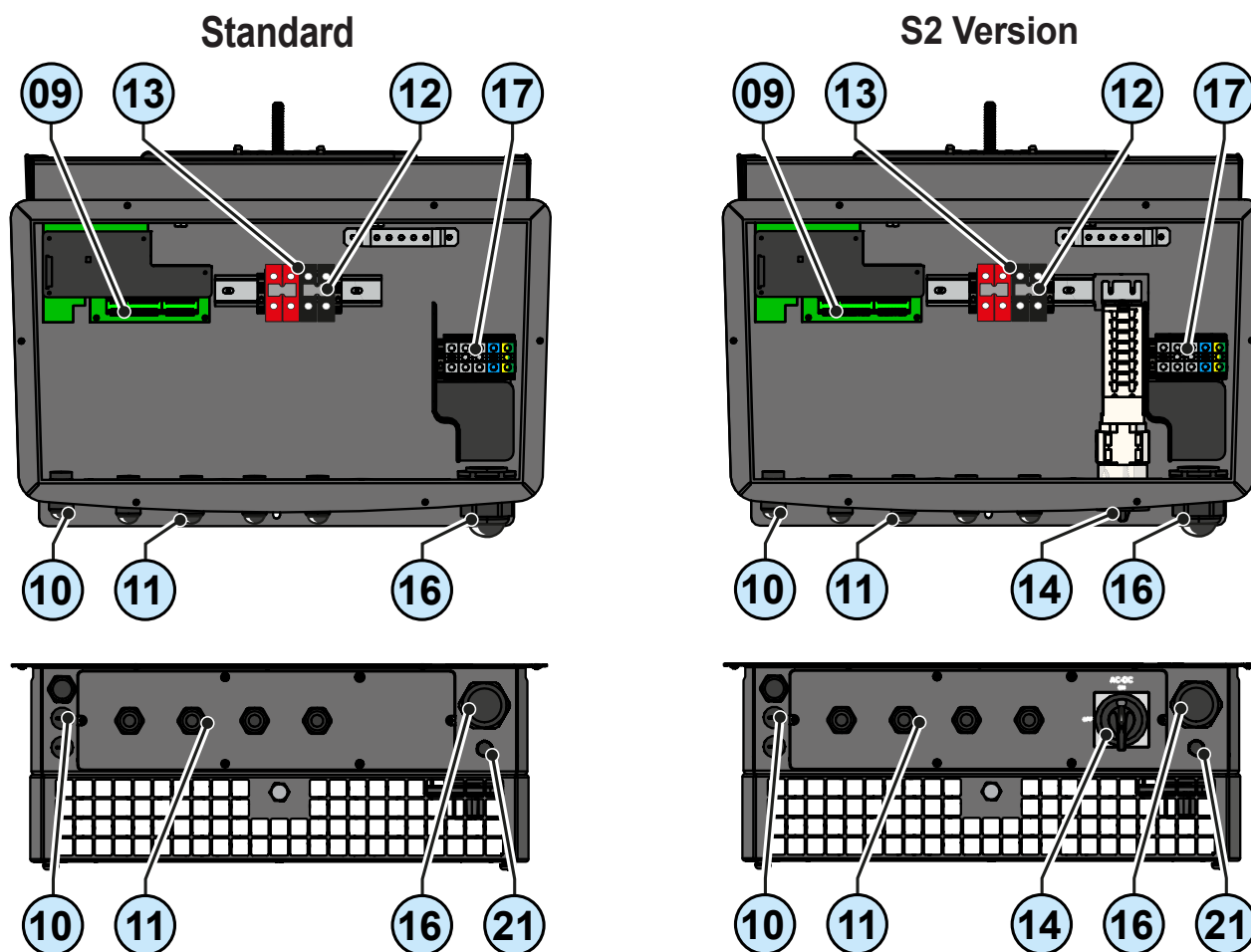

Table: electrical system components

Ref.	Description
⑨	communication card
⑩	service cable glands
⑪	DC cable glands
⑫	jumpers
⑬	DC input terminal board
⑭	AC+DC disconnect switch
⑮	AC cable gland
⑯	AC output terminal board
⑰	Input connectors (MPPT1)
⑱	Input connectors (MPPT2)
⑲	anti-condensation valve
a01	Switch for setting parallel-connected or independent input channels
a05	Rotary switches for setting the country and the language of the display

-S2X / -S2F Version

TRIO-XX.X-TL-OUTD-S2F: S2F wiring box version, with snap-together connectors, string fuses (22) and AC+DC switch (14).

TRIO-XX.X-TL-OUTD-S2X: S2X wiring box version, more complete version with quick fit connectors, string fuses (22), DC overvoltage surge arresters (15), AC overvoltage surge arresters (18) and AC+DC disconnect switch (14).

S2F Version

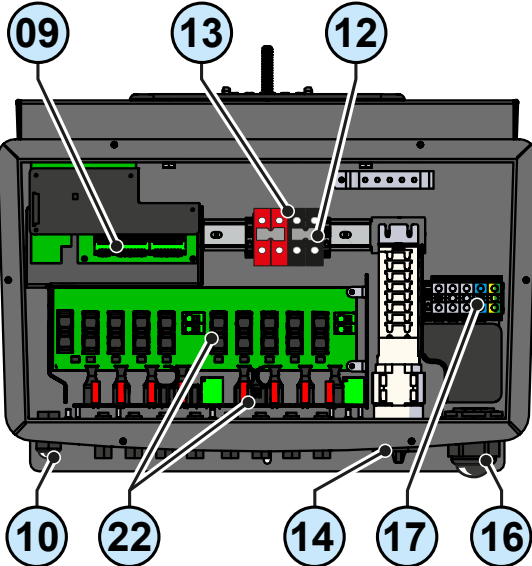

S2X Version

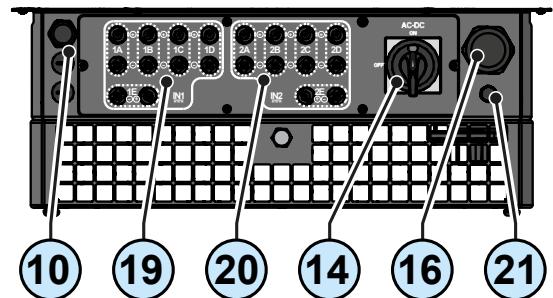
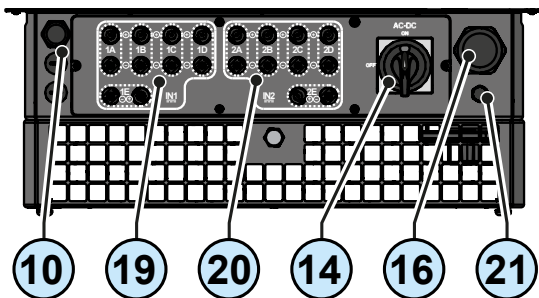
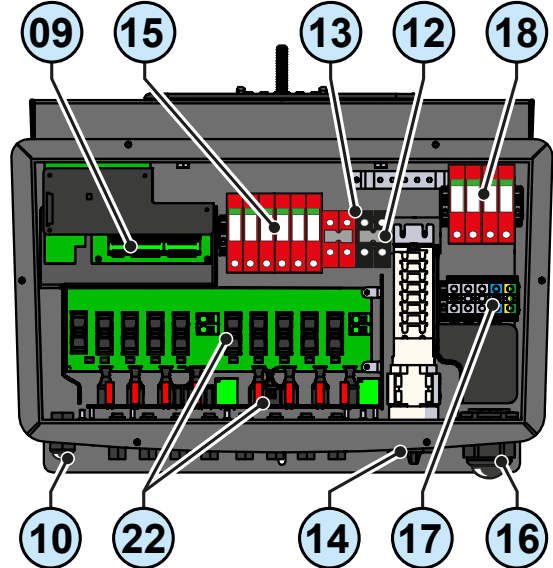
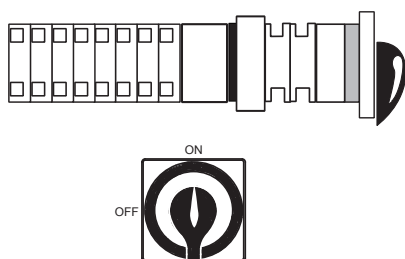

Table: electrical system components

Ref.	Description
09	communication card
10	service cable glands
11	DC cable glands
12	jumpers
13	DC input terminal board
14	AC+DC disconnect switch
15	DC overvoltage surge arresters
16	AC cable gland
17	AC output terminal board
18	AC overvoltage surge arresters
19	Input connectors (MPPT1)
20	Input connectors (MPPT2)
21	anti-condensation valve
22	string fuses
a01	Switch for setting parallel-connected or independent input channels
a05	Rotary switches for setting the country and the language of the display

Principal wiring box components



AC+DC switch ⁽¹⁴⁾ (wiring box S2 / S2F / S2X)

Model: Telergon TFV1031E25501 or equivalent

AC side		
Voltage	Utilisation category	Current
415Vac	AC22A	50A
DC side (per individual input channel)		
Voltage	Utilisation category	Current
1000Vdc	DC21B	40A

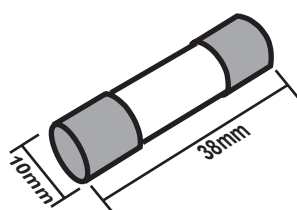

String fuses ⁽²²⁾ (wiring box S2F / S2X)

The standard string protection fuses installed on the inverter have the following features:

Voltage	Rating	Type
1000Vdc	Max. 20A	gPV

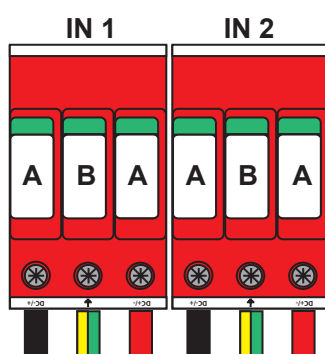

DC surge arresters ⁽¹⁵⁾ (wiring box S2X)

The DC surge arresters installed for each input channel are type Dehn DG M YPV SCI 1000 FM (or equivalent), each composed of three interchangeable cartridges, type DG MOD PV SCI 500 (A) and DG MOD PV 500 (B).

In the event of damage to the surge arresters caused by atmospheric agents, spare part kits may be ordered quoting code KIT SURGE DC SIDE TRIO

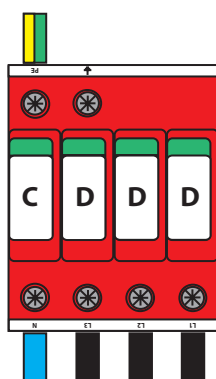

AC surge arresters ⁽¹⁸⁾ (wiring box S2X)

The AC surge arresters installed are type Dehn DG M TT 275 FM (or equivalent), composed of four interchangeable cartridges, type DG MOD 275 (D) and DG MOD NPE (C).

In the event of damage to the surge arresters caused by atmospheric agents, spare part kits may be ordered quoting code KIT SURGE AC SIDE TRIO

Characteristics and technical data

Table: Technical Data **TRIO-20.0-TL-OUTD** **TRIO-27.6-TL-OUTD**

Input		
Rated Input Power (P_{dcr})	20750 Wp	28600 Wp
Maximum Input Power (P_{dcmax})	22700 Wp	31000 Wp
Rated Input Voltage (V_{dcr})	620 V	
Input Activation Voltage (V_{start})	360 V (adj. 250...500 V)	
Input operating range ($V_{dcmin}...V_{dcmax}$)	0.7 x $V_{start}...950$ V	
Input voltage interval for MPP	200...950V	
Maximum Input Power for each MPPT	12000 W	16000 W
Input voltage Range for Operation at rated power with Configuration of the MPPTs in parallel	440...800 V	500...800 V
DC Power Limitation for each MPPT with Independent Configuration of MPPT at P_{acr} , max unbalance example	12000 W [480V ≤ VMPPT ≤ 800V] the other channel: P_{dcr} - 12000W [350V ≤ VMPPT ≤ 800V]	16000 W [500V ≤ VMPPT ≤ 800V] the other channel: P_{dcr} - 16000W [400V ≤ VMPPT ≤ 800V]
Absolute Maximum Input Voltage ($V_{max,abs}$)	1000 V	1000 V
Power derating vs. Input voltage (parallel or independent MPPT configuration)	Linear Derating From MAX to Null [800V ≤ Vmppt ≤ 950V]	
Number of Independent MPPTs	2	
Maximum DC Input Current (I_{dcmax})/for each MPPT ($I_{MPPTmax}$)	50A / 25A	64A / 32A
Maximum Return current (AC side vs DC side)	Negligible	
Number of DC Connection Pairs in Input for each MPPT	1 - Standard and -S2 Version 4 - -S2F / -S2X version	1 - Standard and -S2 Version 5 - -S2F / -S2X version
Type of Input DC Connectors	Tool Free PV Connector Weidmüller / Multi-Contact (Screw Terminal Block on Standard and -S2 versions)	
Type of photovoltaic panels that can be connected at input according to IEC 61730	Class A	
Input protection		
Reverse Polarity Protection	Protection for the Inverter only, from a current limited source, for standard and -S2 versions, and for versions with fuses that have max 2 strings connected	
Input Overvoltage Protection - Varistors	2 for each MPPT	
Input Overvoltage Protection - DIN rail surge arrester (-S2X version)	3 (Class II) for each MPPT	
Short Circuit Input Current	30.0 A	40.0 A
Isolation Control	In accordance with the local standard	
Maximum input-ground capacity	(0.12uF/kW)*20kW=2.4uF	(0.12uF/kW)*27.6kW=3.3uF
DC disconnect switch (-S2, -S2F and -S2X versions)	40 A / 1000 V	
Fuses (-S2F and -S2X versions)	gPV / 1000 V / Max. 20A	
Output		
AC connection to the Grid	Three phase 3W or 4W+PE	
Rated output voltage (V_{acr})	400 Vac	
Output Voltage Range ($V_{acmin}...V_{acmax}$)	320...480 Vac ⁽¹⁾	
Rated Output Power (P_{acr})	20000 W	27600 W
Maximum Output Power (P_{acmax})	22000 W ⁽³⁾	30000 W ⁽⁴⁾
Maximum Output Current (I_{acmax})	33.0 A	45.0 A
Contribution to short-circuit current	35.0 A	46.0 A
Inrush current	Negligible	
Maximum fault current	<63Arms(100mS)	

Table: Technical Data	TRIO-20.0-TL-OUTD	TRIO-27.6-TL-OUTD
Rated Output Frequency (fr)	50 Hz	
Output Frequency Range (fmin...fmax)	47...53 Hz ⁽²⁾	
Maximum apparent Output Power (S _{acmax})	22200VA	30000 VA
Rated Power Factor (Cosφ _{iacr})	The rated power P _{acr} is also guaranteed with cos(φ) = 0.9 >0.995, adj. ±0.9 with P _{acr} =20.0 kW, ± 0.8 with max 22.2kVA	
Total Harmonic Distortion of Current	< 3%	
Type of AC Connections	Screw terminal board, maximum cross-section 35 mm ²	
Output protection		
Anti-islanding Protection	In accordance with the local standard	
Maximum AC Overcurrent protection	34.0 A	46.0 A
Output Overvoltage Protection - Varistors	4	
Output Overvoltage Protection - DIN Rail surge arrester (-S2X version)	4 (Class II)	
Operating performance		
Maximum Efficiency (η _{max})	98.2%	
Weighted Efficiency (EURO/CEC)	98.0% / 98.0%	
Power Input Threshold	40 W	
Stand-by Consumption	< 8W	
Night-time Consumption	<1W	
Night-time Consumption (Reactive Power)	110 VAR	
Inverter Switching Frequency	15.8 kHz	
Communication		
Wired Local Monitoring (opt.)	PVI-USB-RS485_232 (opt.), PVI-DESKTOP (opt.)	
Remote Monitoring (opt.)	PVI-AEC-EVO (opt.), VSN 700 DATALOGGER (opt.)	
Wireless Local Monitoring (opt.)	PVI-DESKTOP (opt.) with PVI-RADIOMODULE (opt.)	
User Interface	Graphic Display	
Environmental		
Ambient Temperature	-25...+60°C / -13...140°F with derating above 45°C/113°F	
Storage Temperature	-40...80°C (-40...+176°F)	
Relative Humidity	0...100% condensing	
Noise Emission	< 50 db(A) @ 1 m	
Maximum Operating Altitude	2000 m / 6560 ft	
Environmental pollution classification for external environment	3	
Environmental Category	External	
Physical		
Environmental Protection Rating	IP 65	
Cooling system	Natural	
Overvoltage Category in accordance with IEC 62109-1	II (DC input)	III (AC output)
Dimensions (H x W x D)	1061 x 702 x 292 mm	41.7" x 27.6" x 11.5"
Weight	Standard e -S2: 67kg / 147lb -S2F / S2X: 75 kg / 165 lb	Standard e -S2: 72 kg / 158 lb -S2F / S2X: 80 kg / 176 lb
Packaging Dimensions (H x W x D)	737 x 800 x 1200 mm / 29" x 31.5" x 47.2"	
Full Packaging Weight	Standard e -S2: 79kg / 174lb -S2F / S2X: 87 kg / 191 lb	Standard e -S2: 84 kg / 185 lb -S2F / S2X: 92 kg / 202 lb
Mounting System	Wall bracket	
Exposure to UV rays	Plastic covers suitable for outdoor use. Exposure to UV rays (in accordance with UL 746C)	
Safety		
Safety Class	I	



Table: Technical Data	TRIO-20.0-TL-OUTD	TRIO-27.6-TL-OUTD
Isolation Level	Transformerless	
Marking	CE	
Safety and EMC Standard	EN 50178, EN 62109-1, EN 62109-2, AS/NZS3100, AS/NZS 60950, EN61000-6-2, EN61000-6-3, EN61000-3-11, EN61000-3-12	

1. The AC voltage range may vary depending on specific country grid standard

2. The Frequency range may vary depending on specific country grid standard

3. Limited to 20000 W for Germany

4. Limited to 27600 W for Germany

Remark. Features not specifically listed in the present data sheet are not included in the product



Tightening torques

To maintain the IP65 protection of the system and for optimal installation, the following tightening torques must be used:

AC cable gland ⑩ PG36	7.5 Nm
Service cable glands ⑩ M25	5.0 Nm
Service cable glands ⑩ M20	2.7 Nm
DC cable glands ⑪ M25 (basic and S2 versions)	5.0 Nm
Wiring box ⑫	2.4 Nm
DC input terminal board ⑬ 50 mm ² (basic and S2 versions only)	6.0 Nm
AC output terminal board ⑭ 35 mm ²	2.5 Nm
Quick fit connectors MC4 or Weidmuller	2.5 Nm

Overall dimensions

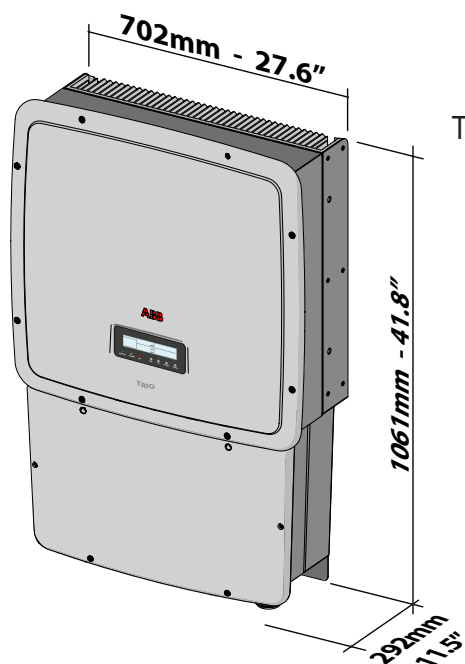

The overall dimensions are expressed in mm and in inches

Bracket dimensions

The overall dimensions are expressed in mm and in inches

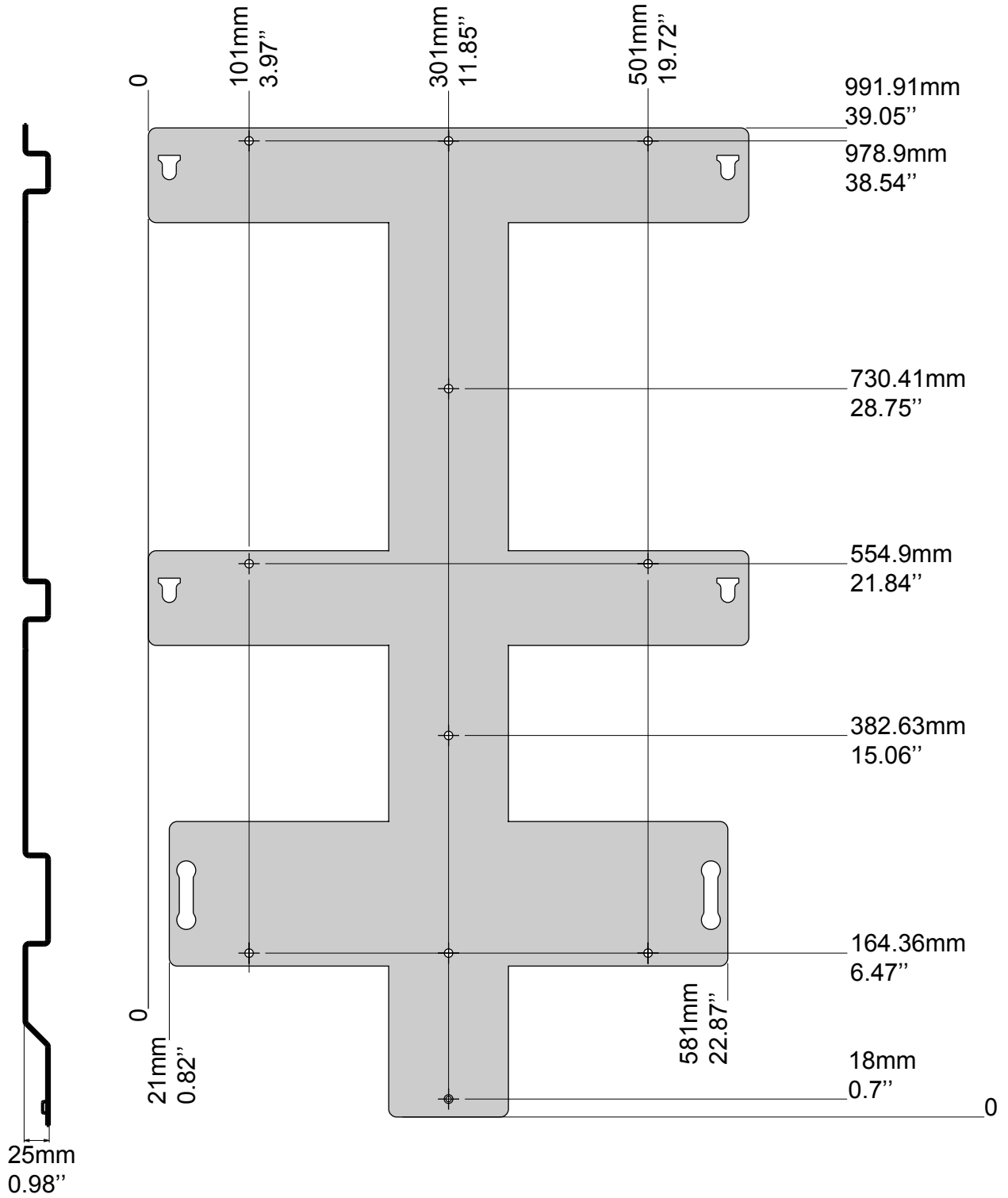

Efficiency curves

The equipment was designed in consideration of current energy conservation standards, to avoid waste and unnecessary leakage.

Graphs of the efficiency curves of all models of inverter described in this manual are shown below.

The efficiency curves are linked to technical parameters that are continually being developed and improved and should therefore be considered approximate.



- TRIO-20.0-TL-OUTD-400
- TRIO-20.0-TL-OUTD-S2-400
- TRIO-20.0-TL-OUTD-S2F-400
- TRIO-20.0-TL-OUTD-S2X-400

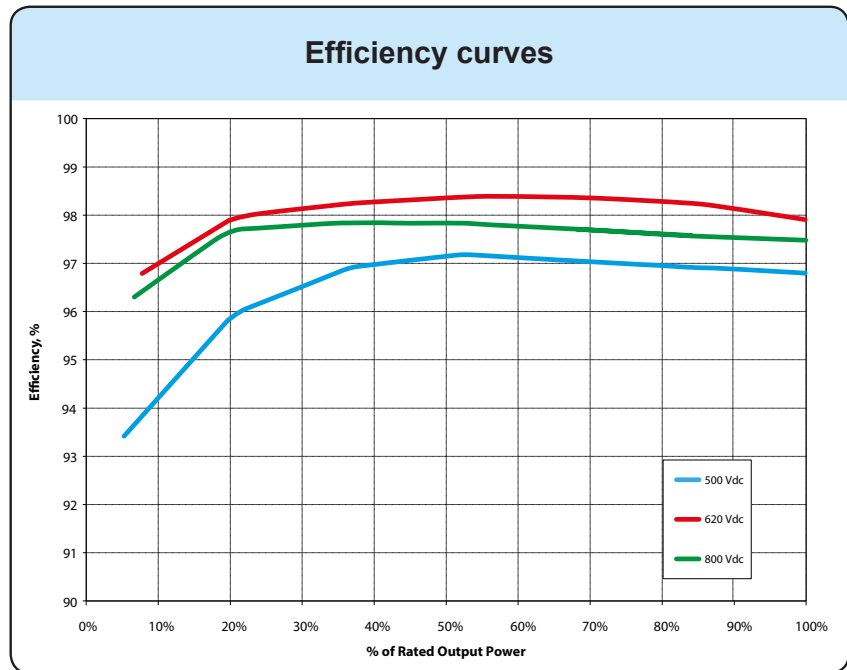

- TRIO-27.6-TL-OUTD-400
- TRIO-27.6-TL-OUTD-S2-400
- TRIO-27.6-TL-OUTD-S2F-400
- TRIO-27.6-TL-OUTD-S2X-400

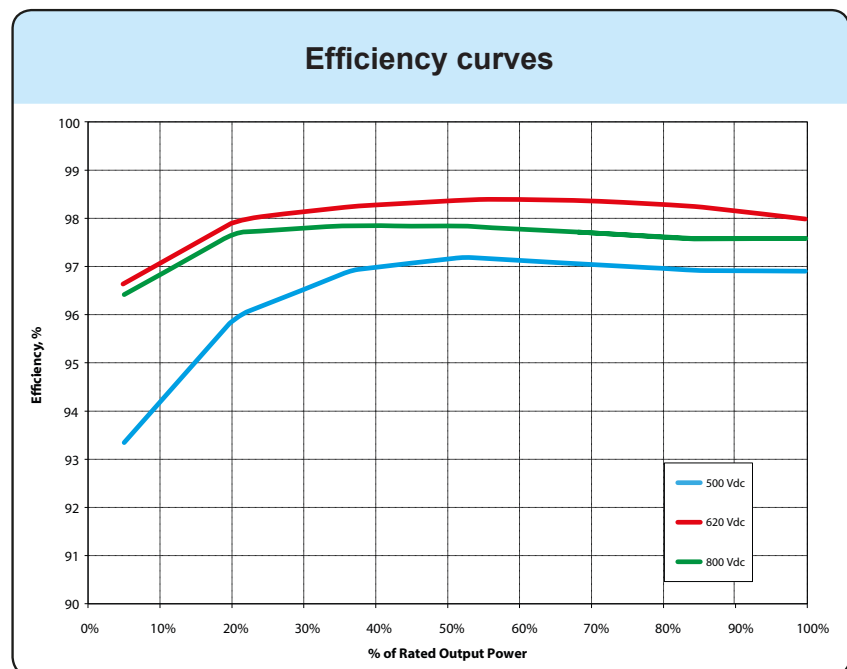

Power derating

In order to allow inverter operation in safe thermal and electrical conditions, the unit automatically reduces the value of the power fed into the grid.

Power limiting may occur due to:

- Adverse environmental conditions (thermal derating)
- Percentage of output power (value set by the user)
- Grid voltage over frequency (mode set by user)
- Grid over voltage $U > 10\text{min Der.}$ (enabling carried out by user)
- Anti-islanding
- Grid under voltage
- Input voltage values too high.
- Input current values too high.



Derating due to environmental conditions

The power reduction value and the inverter temperature at which it occurs depend on the ambient temperature and on many operating parameters. Example: input voltage, grid voltage and power available from the photovoltaic field.

The inverter can therefore reduce the power during certain periods of the day according to the value of these parameters.

In any case, the inverter guarantees the maximum output power even at high temperatures, provided the sun is not shining directly on it.

TRIO-20.0-TL-OUTD-400
 TRIO-20.0-TL-OUTD-S2-400
 TRIO-20.0-TL-OUTD-S2F-400
 TRIO-20.0-TL-OUTD-S2X-400
 TRIO-27.6-TL-OUTD-400
 TRIO-27.6-TL-OUTD-S2-400
 TRIO-27.6-TL-OUTD-S2F-400
 TRIO-27.6-TL-OUTD-S2X-400

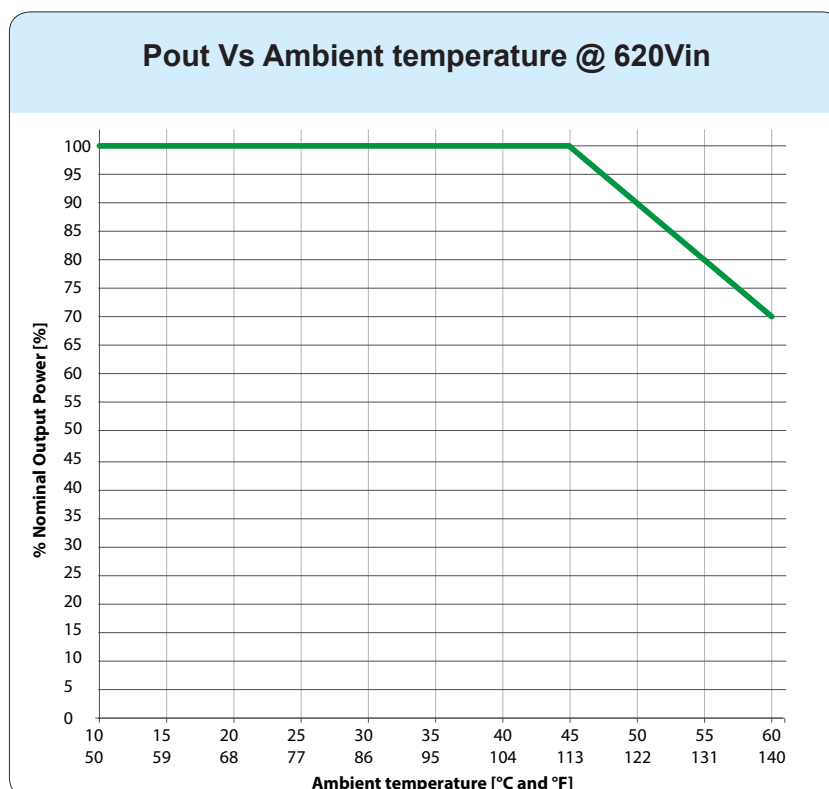

Derating due to the altitude of the installation

The graphs show the derating as a function of the altitude of the installation.

- TRIO-20.0-TL-OUTD-400
- TRIO-20.0-TL-OUTD-S2-400
- TRIO-20.0-TL-OUTD-S2F-400
- TRIO-20.0-TL-OUTD-S2X-400
- TRIO-27.6-TL-OUTD-400
- TRIO-27.6-TL-OUTD-S2-400
- TRIO-27.6-TL-OUTD-S2F-400
- TRIO-27.6-TL-OUTD-S2X-400

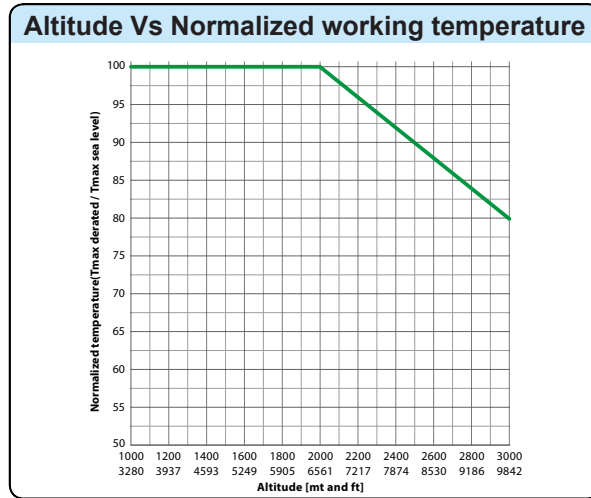

- TRIO-20.0-TL-OUTD-400
- TRIO-20.0-TL-OUTD-S2-400
- TRIO-20.0-TL-OUTD-S2F-400
- TRIO-20.0-TL-OUTD-S2X-400
- TRIO-27.6-TL-OUTD-400
- TRIO-27.6-TL-OUTD-S2-400
- TRIO-27.6-TL-OUTD-S2F-400
- TRIO-27.6-TL-OUTD-S2X-400

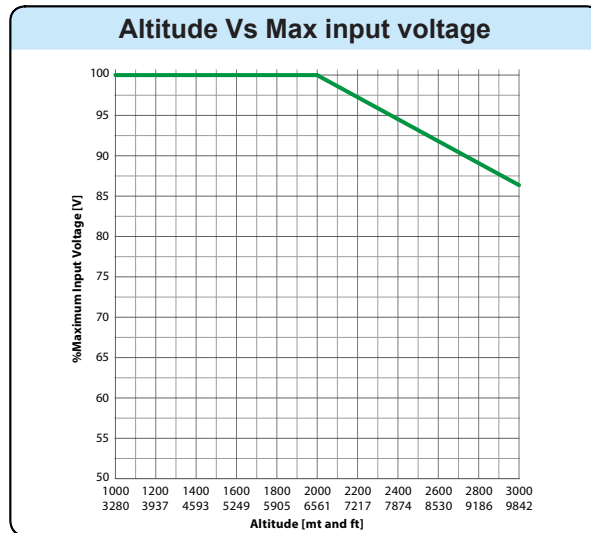

Derating due to the input voltage

The graphs show the automatic reduction of supplied power when input voltage values are too high or too low.

- TRIO-20.0-TL-OUTD-400
- TRIO-20.0-TL-OUTD-S2-400
- TRIO-20.0-TL-OUTD-S2F-400
- TRIO-20.0-TL-OUTD-S2X-400

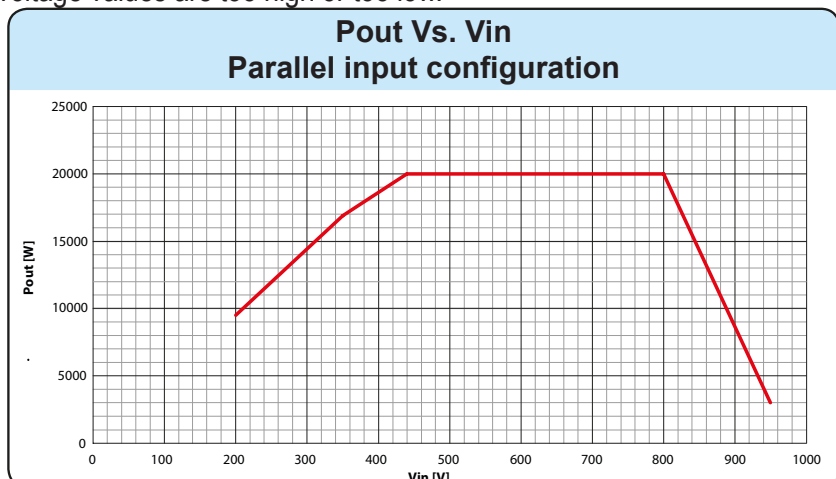

TRIO-20.0-TL-OUTD-400
 TRIO-20.0-TL-OUTD-S2-400
 TRIO-20.0-TL-OUTD-S2F-400
 TRIO-20.0-TL-OUTD-S2X-400

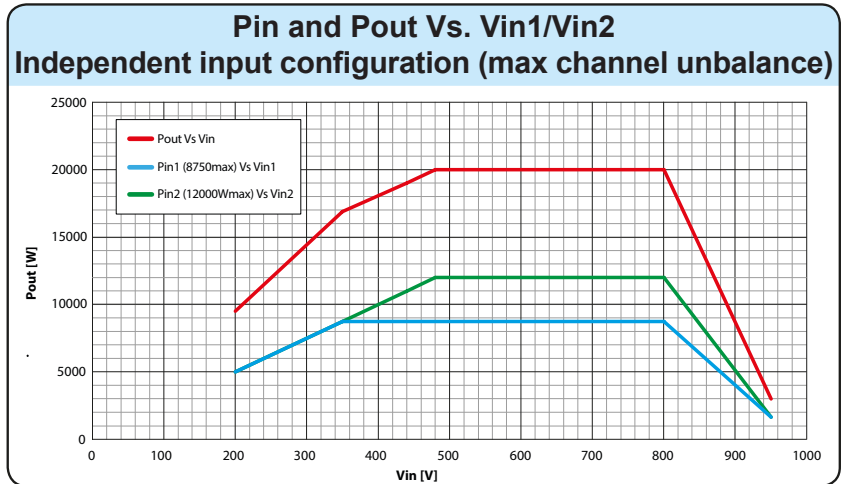

TRIO-27.6-TL-OUTD-400
 TRIO-27.6-TL-OUTD-S2-400
 TRIO-27.6-TL-OUTD-S2F-400
 TRIO-27.6-TL-OUTD-S2X-400

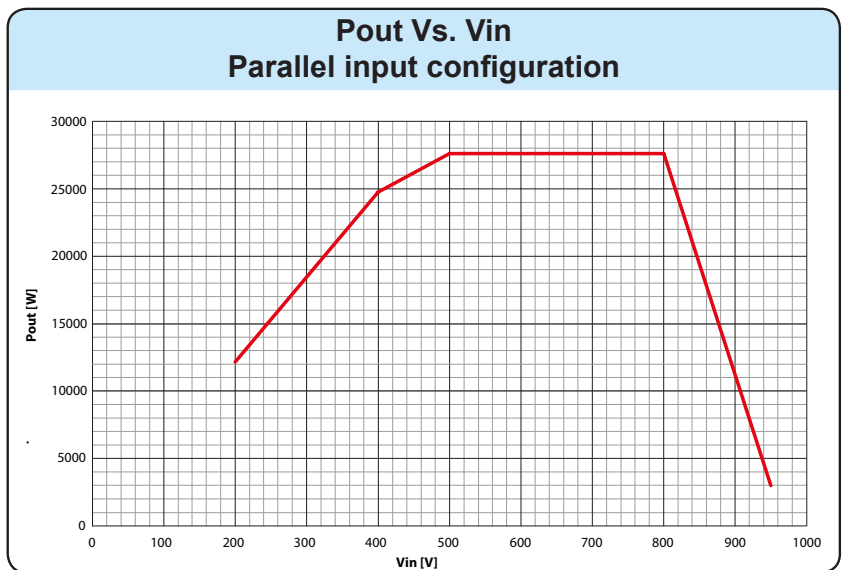

TRIO-27.6-TL-OUTD-400
 TRIO-27.6-TL-OUTD-S2-400
 TRIO-27.6-TL-OUTD-S2F-400
 TRIO-27.6-TL-OUTD-S2X-400

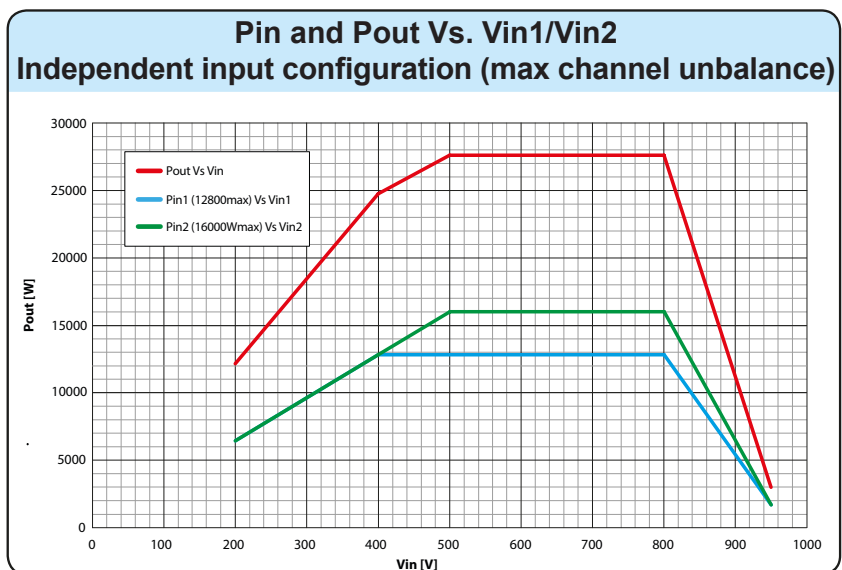

Characteristics of a photovoltaic generator

A PV generator consists of an assembly of photovoltaic panels that transform solar radiation into DC electrical energy and can be made up of:

Strings: X number of PV panels connected in series

Array: group of X strings connected in parallel

Strings and Arrays

In order to considerably reduce the cost of installing a photovoltaic system, mainly associated with the problem of wiring on the DC side of the inverter and subsequent distribution on the AC side, the string technology has been developed. A photovoltaic panel consists of many photovoltaic cells mounted on the same support.

- A string consists of a certain number of panels connected in series.
- An array consists of two or more strings connected in parallel.

Large photovoltaic systems can be made up of several arrays, connected to one or more inverters.

By maximizing the number of panels inserted into each string, it is possible to reduce the cost and complexity of the connection system of the photovoltaic system.

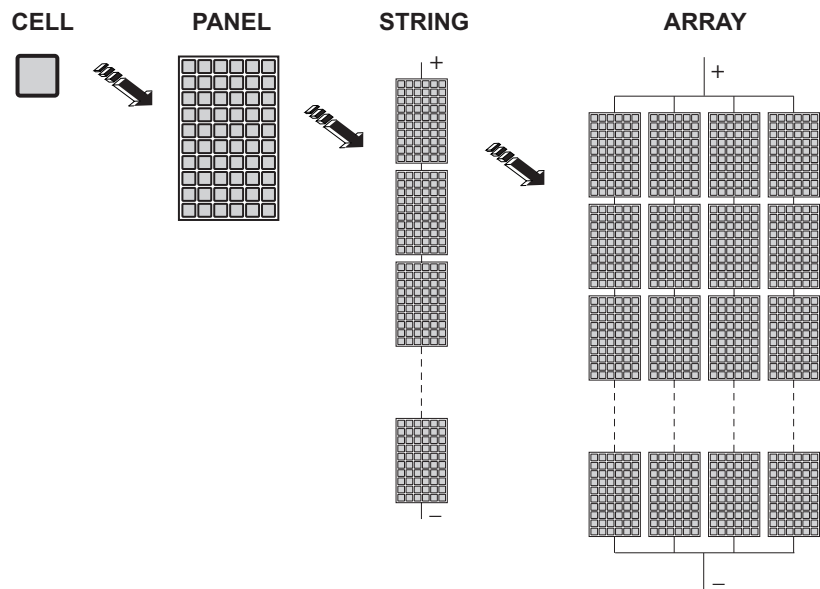

The current of each array must fall within the limits of the inverter.



To work, the inverter must be connected to the national electricity grid since its operation can be equated to a current generator that supplies power in parallel with the grid voltage. That is why inverters cannot support the grid voltage (islanding).

Description of the equipment

This equipment is an inverter that converts direct electric current from a photovoltaic generator into alternating electric current and feeds it into the national grid.

Photovoltaic panels transform energy from the sun into direct current (DC) electrical energy (through a photovoltaic field, also called photovoltaic (PV) generator; in order to use it it is necessary to transform the type of alternating current into "AC". This conversion, known as DC to AC inversion, is made efficiently without using rotating parts and only through static electronic devices.

In order to allow inverter operation in safe thermal and electrical conditions, in the event of adverse environmental conditions or unsuitable input voltage values, the unit automatically reduces the value of the power fed into the grid.

This way the solar energy system compensates for the energy drawn from the utilities connected to the grid to which it is linked.

The solar energy system therefore powers all connected electrical devices, from lighting to household appliances, etc.

When the photovoltaic system is not supplying sufficient power, the power needed to ensure normal operation of the connected electrical devices is drawn from the national grid. If, on the other hand, excess power is produced, this is fed directly into the grid, so becoming available to other consumers.

In accordance with local and national regulations, the power produced can be sold to the grid or credited towards future consumption, so bringing about a saving of money.



Operating diagram

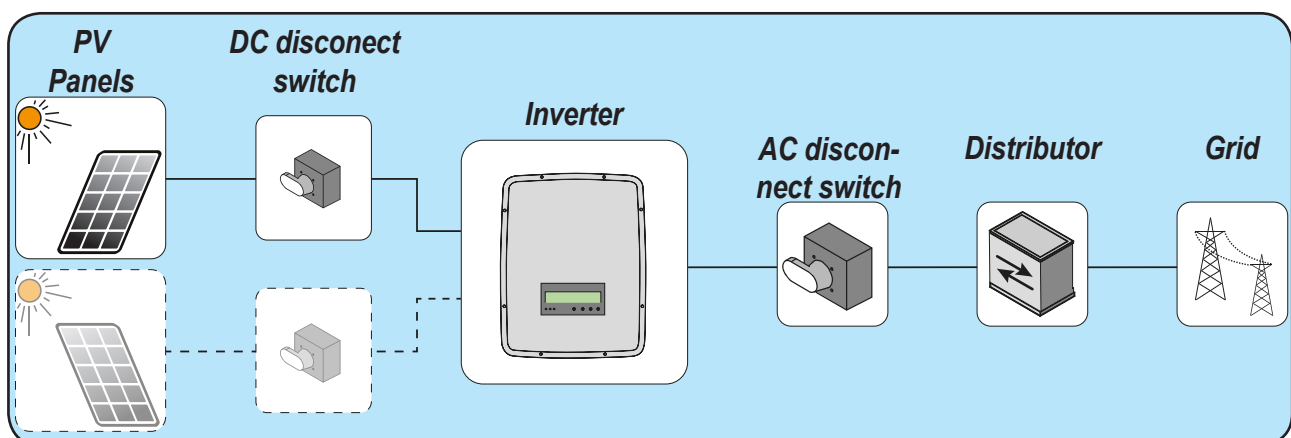

Connection of several inverters together

If the photovoltaic system exceeds the capacity of a single inverter, it is possible to make a multiple connection of inverters to the system, with each one connected to a suitable section of the photovoltaic field, on the DC side, and connected to the grid on the AC side.

Each inverter will work independently of the others and will supply the grid with the maximum power available from its section of photovoltaic panels.



Notes on the sizing of the system

Decisions about how to structure a photovoltaic system depend on a certain number of factors and considerations to make, such as for example, the type of panels, the availability of space, the future location of the system, energy production goals over the long term, etc.

A configuration program that can help to correctly size the photovoltaic system is available on the web site of ABB

Functionality and components of the equipment

Analogue inputs

External analogue sensors for monitoring the environmental conditions (temperature, sunlight, etc.) can be connected to the inverter. The analogue sensors are set directly from the display menus.

Configurable relay

The inverter has a configurable switching relay that can be used in various operating conditions set in the dedicated menu. A typical application example is the closing of the contact when an alarm occurs.



Remote switching on/off

This control can be used to switch the inverter on/off through an external (remote) control.

This function must be enabled in the menu, and if activated, the switching on of the inverter depends on the external switching on/off control as well as being dictated by the presence of the normal parameters that allow the inverter to connect to the grid.

Feeding reactive power into the grid

The inverter is able to produce reactive power and can therefore feed it into the grid through the setting of the phase shift factor. Feed-in management can be controlled directly by the grid company through a dedicated RS485 serial interface or set on the display, or through the Aurora Manager LITE configuration software.

The feed-in management methods vary according to the country of installation and the relevant grid companies. For detailed information about the parameters and characteristics of this function, please contact ABB directly.

Limiting the active power fed into the grid

The inverter, if enabled and set using the display or the Aurora Manager configuration software, can limit the amount of active power fed into the grid by the inverter to the desired value (expressed as a percentage).

Monitoring string inputs (versions S2F / S2X only)

If enabled from the display or through the Aurora Manager LITE configuration software, the inverter can monitor and display the voltage and current of each individual string input.

It also checks the status of the string fuses (both positive and negative) and generates a warning in the event of a fault (visible on the display).

Monitoring surge arresters (S2X versions only)

The inverter monitors the status of the surge arresters (both AC and DC) and generates a warning in the event of a fault (visible on the display).

Data transmission and control

The inverter or networks of several inverters can be monitored locally or remotely using an advanced communication system based on a RS-485 serial interface that can be configured to communicate using the proprietary “Aurora” or public “ModBus RTU” protocol (PMU RS485 port).



Topographic diagram of the equipment

The diagram shown is a topographic diagram of the operation of the inverter.

The main blocks are the input DC-DC converters (called “boosters”) and the output inverter. Both the DC-DC converters and the output inverter operate at a high switching frequency and so enable a compact size and relatively light weight to be achieved.

Each of the input converters is dedicated to a separate array with independent maximum power point tracking (MPPT) control.

This means that the two arrays can be installed with different positions and orientation. Each array is controlled by an MPPT control circuit.

The two trackers can be configured (when required) in parallel, to handle power and/or current levels higher than those a single tracker can handle.

This version of inverter is transformerless, meaning it has no galvanic isolation between input and output, which enables a further increase in conversion efficiency. The inverter is already equipped with all the necessary protective devices for safe operation in compliance with the regulations, even without an isolation transformer.

The inverter is controlled by two independent DSPs (Digital Signal Processors) and a central microprocessor.

The connection to the electricity grid is therefore controlled by two independent computers, in full compliance with electrical standards regarding system powering and safety.

The operating system performs the operation of communicating with the relevant components to carry out data analysis.

All this guarantees optimal operation of the entire unit and high efficiency in all insolation and load conditions, always in full compliance with the relevant directives, standards and provisions.



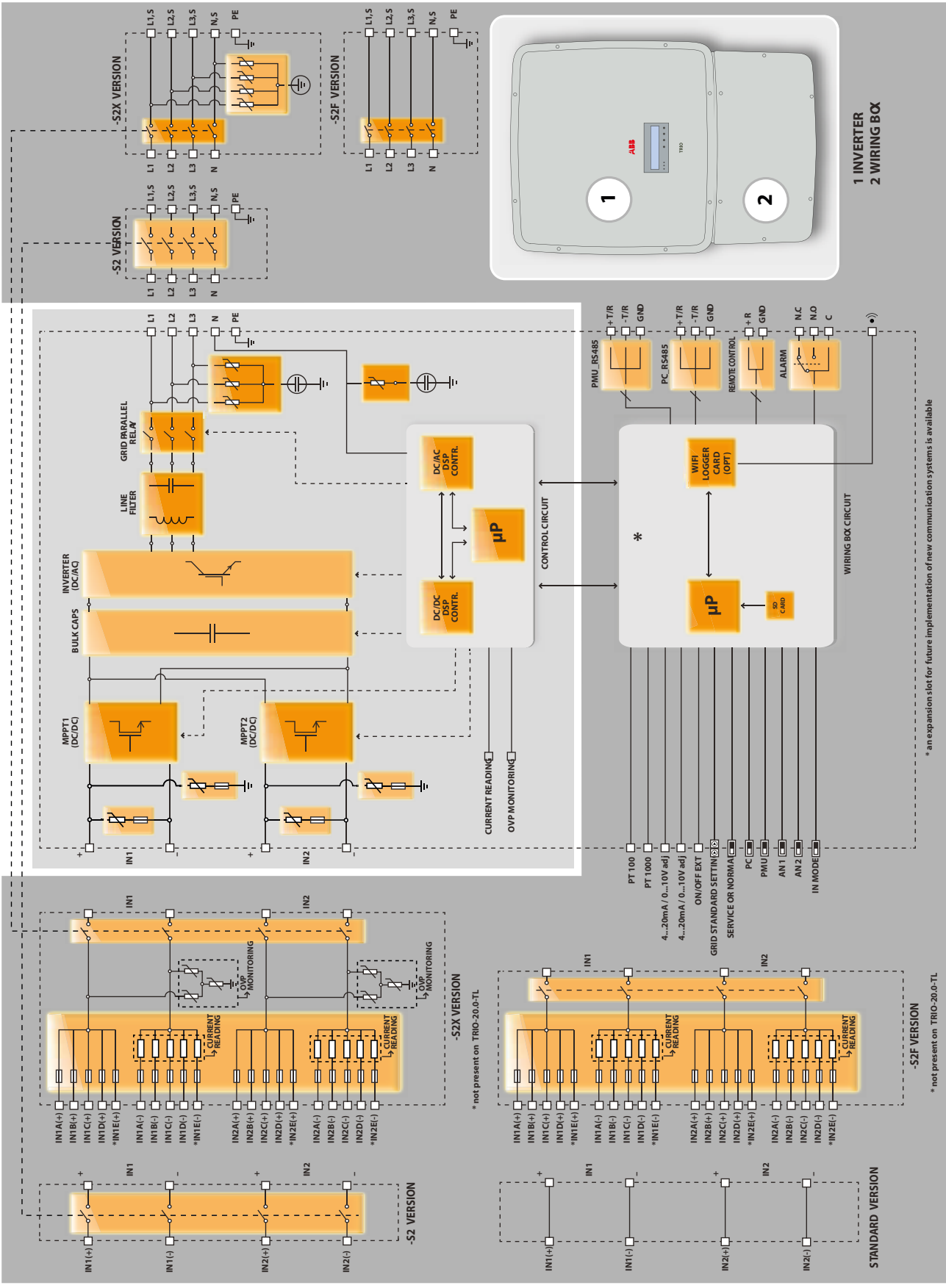

*an expansion slot for future implementation of new communication systems is available

* not present on TRIO-20.0-TL

* not present on TRIO-20.0-TL

Protective devices

Anti-Islanding

In the event of a local grid outage by the electricity company, or when the equipment is switched off for maintenance operations, the inverter must be physically disconnected safely, to ensure protection of people working on the grid, all in accordance with the relevant national standards and laws. To prevent possible islanding, the inverter is equipped with an automatic protective disconnection system called “Anti-Islanding”.



Anti-islanding protection mechanisms are different depending on the grid standards, even if they all have the same purpose.

Ground fault in the photovoltaic panels

This inverter must be used with panels connected with “floating” connections, that is, with positive and negative terminals without ground connections. An advanced ground fault protection circuit continuously monitors the ground connection and disconnects the inverter when a ground fault is detected. The ground fault condition is indicated by a red “GFI” LED on the front panel.

String fuses

In the S2F / S2X versions, string fuses ②② that protect the equipment from currents above the limit value, independently for each string, are pre-installed inside the wiring box ②②.

The sizing of the fuses must be carefully considered during installation.

Overvoltage surge arresters

As additional protection to prevent damage caused by lightning discharges and electrostatic induction phenomena, DC overvoltage surge arresters ①⑤ and AC overvoltage surge arresters ①⑧ are integrated inside the wiring box ②② (S2X versions).

Further protective devices

The inverter is equipped with additional protective devices to guarantee safe operation in any circumstance. These protective devices include:

- Continuous monitoring of the grid voltage to ensure the voltage and frequency values stay within operating limits;
- Control of internal temperatures to automatically limit the power if necessary to ensure the unit does not overheat (derating).

The numerous control devices produce a replete structure to guarantee totally safe operation.

Safety instructions and general information

The equipment has been manufactured in accordance with the strictest accident-prevention regulations and supplied with safety devices suitable for the protection of components and operators.



For obvious reasons, it is not possible to anticipate the great number of installations and environments in which the equipment will be installed; it is therefore necessary for the customer to appropriately inform the manufacturer about particular installation conditions.

ABB accepts no liability for failure to comply with the instructions for correct installation are cannot be held responsible for the systems upstream or downstream of the equipment it has supplied.



It is essential to provide operators with correct information. They must therefore read and comply with the technical information given in the manual and in the attached documentation.



The instructions given in the manual do not replace the safety devices and technical data for installation and operation stuck on the product, and they certainly do not replace the safety regulations in force in the country of installation and common sense rules.

The manufacturer is willing to train staff, at its premises or on site, in accordance with conditions to be set out in the contract.



Do not use the equipment if you find any operating anomalies.

Avoid temporary repairs. All repairs should be carried out using only genuine spare parts, which must be installed in accordance with their intended use.

Liabilities arising from commercial components are delegated to the respective manufacturers.

Hazardous areas and operations

Environmental conditions and risks

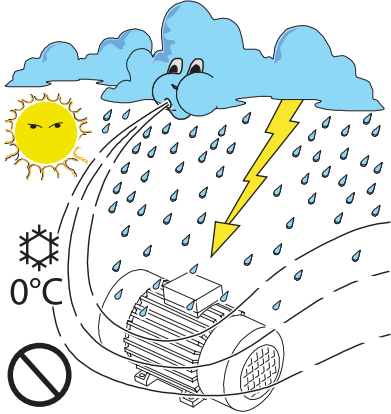

The equipment can be installed outdoors, but only in environmental conditions that do not prevent its regular operation. These conditions are reported on the technical data and on installation chapter.

ABB CANNOT be held responsible for disposal of the equipment: displays, cables, batteries, accumulators, etc., and therefore the customer must dispose of these substances, which are potentially harmful to the environment, in accordance with the regulations in force in the country of installation.



The same precautions should be adopted for dismantling the equipment.



The equipment is not equipped to operate in environments that have particular flammability or explosive conditions.

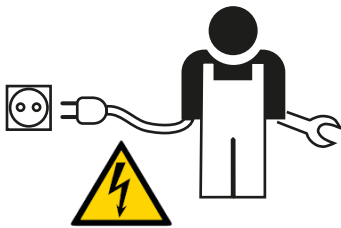

The customer and/or installer must appropriately train operators or anyone who may come near the equipment, and highlight, if necessary with notices or other means, the hazardous areas or operations at risk if required: magnetic fields, hazardous voltages, high temperatures, possibility of discharges, generic hazard, etc.

Signs and Labels



The labels attached to the equipment must absolutely **NOT** be removed, damaged, dirtied, hidden, etc.

The labels must be cleaned regularly and kept visible at all times, that is, they must **NOT** be hidden with objects and extraneous parts (rags, boxes, equipment, etc.)

The technical data shown in this manual do not in any case replace those shown on the labels attached to the equipment.

Thermal hazard



WARNING: removal of guards or covers is allowed only 10 minutes after the voltage has been removed; ; this is to let components cool down and allow any electrostatic charges and parasitic voltages to be discharged.

When the equipment has just been switched, it may have hot parts, as a result of overheating of the surfaces at temperature (e.g.: transformers, accumulators, coils, etc.) so be careful where you touch.

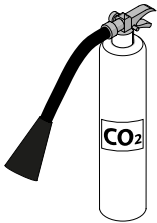

In the event of fire, use CO₂ extinguishers and use auto extraction systems to fight fire in closed environments.



Clothing and protective devices for staff

ABB has eliminated sharp edges and corners, but in some cases it is not possible to do anything, and we therefore advise wearing the clothing and personal protective devices provided by the employer.



Staff must not wear clothes or accessories that can start fires or generate electrostatic charges or, in gener, clothing that can impede personal safety.



All operations on the equipment should be performed with suitably insulated clothes and instruments.

E.g.: Insulated gloves (class 0, category RC)

Maintenance operations must be carried out with the equipment disconnected from the grid and from the photovoltaic generator.

Staff must **NOT** go near the equipment with bare feet or wet hands.

The maintenance technician must in any case make sure no one else can switch on or operate the equipment during the maintenance operations, and must report any anomaly or damage due to wear or ageing so that the correct safety conditions can be restored.

The installer or maintenance technician must always pay attention to the work environment, so that it is well lit and has sufficient spaces to ensure they have an escape route.



In the installation, consider or make sure the **noise emitted based on the environment** is not such that it exceeds thresholds allowed by law (less than 80 dBA).

Residual risks



Despite the warnings and safety systems, there are still some residual risks that cannot be eliminated.

These risks are listed in the following table with some suggestions to prevent them.

Table of residual risks

RISK ANALYSIS AND DESCRIPTION	SUGGESTED REMEDY
Noise pollution due to installation in unsuitable environments or where staff work permanently.	Reassess the environment or the place of installation.
Suitable local ventilation that does not cause overheating of the equipment and is sufficient not to create discomfort to people in the room.	Restore suitable ambient conditions and air the room.
External weather conditions, such as water seepage, low temperatures, high humidity, etc.	Maintain ambient conditions suitable for the system.
Overheating of surfaces at temperature (transformers, accumulators, coils, etc.) can cause burns. Also be careful not to block the cooling slits or systems of the equipment.	Use suitable protective equipment or wait for the parts to cool down before switching on the equipment.
Inadequate cleaning: compromises cooling and does not allow the safety labels to be read.	Clean the equipment, labels and work environment adequately.
Accumulation of electrostatic energy can generate hazardous discharges.	Ensure the devices have discharged their energy before working on them.
Inadequate training of staff.	Ask for a supplementary course.
During installation, temporarily mounting the equipment or its components may be risky.	Be careful about and disallow access to the installation area.
Accidental disconnections of the quick-fit connectors with the equipment in operation, or wrong connections, may generate electric arcs	Be careful about and disallow access to the installation area.



General conditions

Some recommendation apply only to large size product or multiple small size packings.

Transport and handling

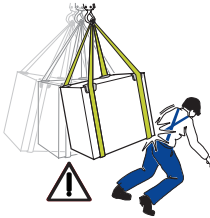

Transport of the equipment, especially by road, must be carried out with by suitable ways and means for protecting the components (in particular, the electronic components) from violent shocks, humidity, vibration, etc.

During handling, do not make any sudden or fast movements that can create dangerous swinging.

Lifting



ABB usually stores and protects individual components by suitable means to make their transport and subsequent handling easier, but as a rule it is necessary to turn to the experience of specialized staff in change of loading and unloading the components.

Where indicated and/or where there is a provision, eyebolts or handles, which can be used as anchorage points, are inserted and/or can be inserted.

The ropes and means used for lifting must be suitable for bearing the weight of the equipment.

Do not lift several units or or parts of the equipment at the same time, unless otherwise indicated.

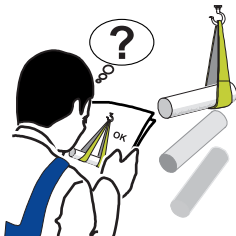
Unpacking and checking

We remind you that the packaging elements (cardboard, cellophane, staples, adhesive tape, straps, etc.) may cause cuts and/or injuries if not handled with care. They should be removed by suitable means and not left in the hands of irresponsible people (e.g., children).







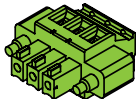
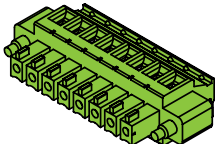

The components of the packaging must be disposed on in accordance with the regulations in force in the country of installation.

When you open the package, check that the equipment is undamaged and make sure all the components are present.

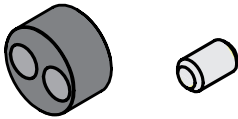
If you find any defects or damage, stop unpacking and consult the carrier, and also promptly inform the Service ABB.

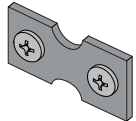
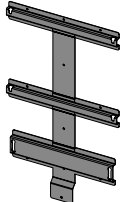
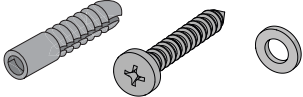
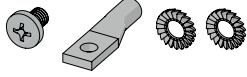
List of components supplied

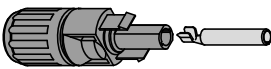
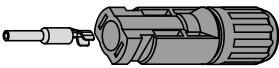
Supplied with the inverter are all the components required to correctly install and connect the inverter

Components available for all models		Q.ty
	Connector for connecting the configurable relay	2
	Connector for connecting the communication and control signals	4
	Male key TORX TX20	1
	Two-hole gasket for M25 signal cable glands and cap	2 + 2
	Two-hole gasket for M20 signal cable glands and cap	1 + 1
	Jumpers for configuration of the parallel input channels	2
	Bracket for wall mounting	1
	Plugs, screws and washers for wall mounting	10 + 10 + 10
	Screw + cable lug + washers for installation of the second protective earthing cable	1 + 1 + 2
	Quick installation guide	1
Components available for the S2F/S2X models only		Q.ty
	Quick fit connectors (female)	8 (20 kW) 10 (27.6 kW)
	Quick fit connectors (male)	8 (20 kW) 10 (27.6 kW)
	Fuses gPV - 1000V DC (may be preinstalled on the inverter)	16 (20 kW) 20 (27.6 kW)



Kit of recommended spare parts

A list of spare parts that are compatible with the TRIO inverter and in stock at the ABB warehouse is given below.

Code	Description	Quantity
TRIO HANDLING KIT	Kit of handles and eyebolts for lifting the inverter part	4 handles 2 eyebolts
KIT 10 FUSES 8A	Kit of 8A fuses (gPV - 1000Vdc)	10
KIT 10 FUSES 10A	Kit of 10A fuses (gPV - 1000Vdc)	10
KIT 10 FUSES 12A	Kit of 12A fuses (gPV - 1000Vdc)	10
KIT 10 FUSES 15A	Kit of 15A fuses (gPV - 1000Vdc)	10
KIT SURGE DC SIDE TRIO	Kit of spare cartridges for DC side surge arresters	4 (Dehn PN. 952051) 2 (Dehn PN. 952041)
KIT SURGE AC SIDE TRIO	Kit of spare cartridges for AC side surge arresters	3 (Dehn PN. 952010) 1 (Dehn PN. 952050)

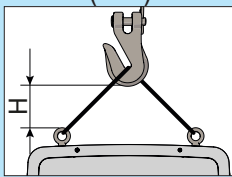
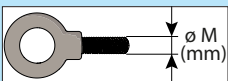

Weight of the equipment units

Table: Weights	Weight (kg/lb)	Lifting points (n°#)	Minimum height of ropes (mm)	Holes or Eyebolts UNI2947
				
INVERTER unit	TRIO-20.0: 60kg/132lb TRIO-27.6: 65kg/143lb	4	1.200	M 12 mounting kit with handles ⑥ and eyebolts (to order)
WIRING BOX unit	Standard / -S2: 7kg/15.5lb -S2F / -S2X: 15kg/33lb	2	-	-

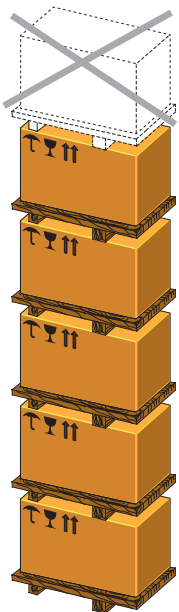

If the package is stored correctly, it can withstand a maximum load of 5 pieces of equipment. DO NOT stack with equipment or products other than those indicated.

Types of lifting

Because of its weight, the inverter unit must be lifted by two people or alternatively using suitable lifting equipment. It is possible to fit 4 handles in the side holes provided, to make the inverter easier to handle. When using cables to lift, two eyebolts can be fitted (one on each side) using the upper holes only.

The handles and eyebolts can be ordered using the code "TRIO HANDLING KIT"

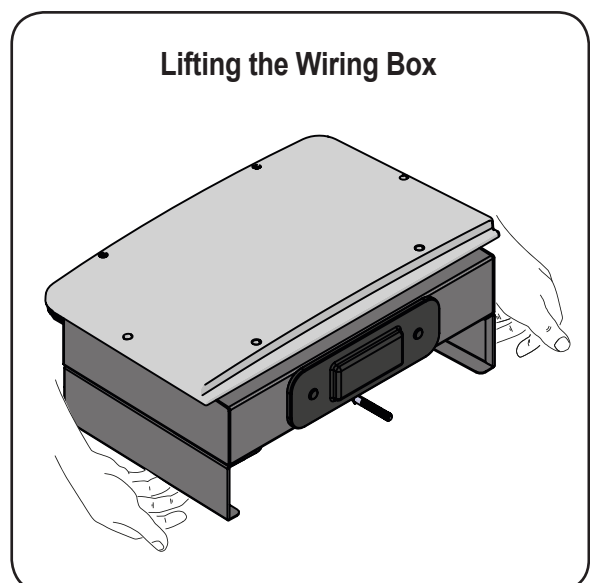
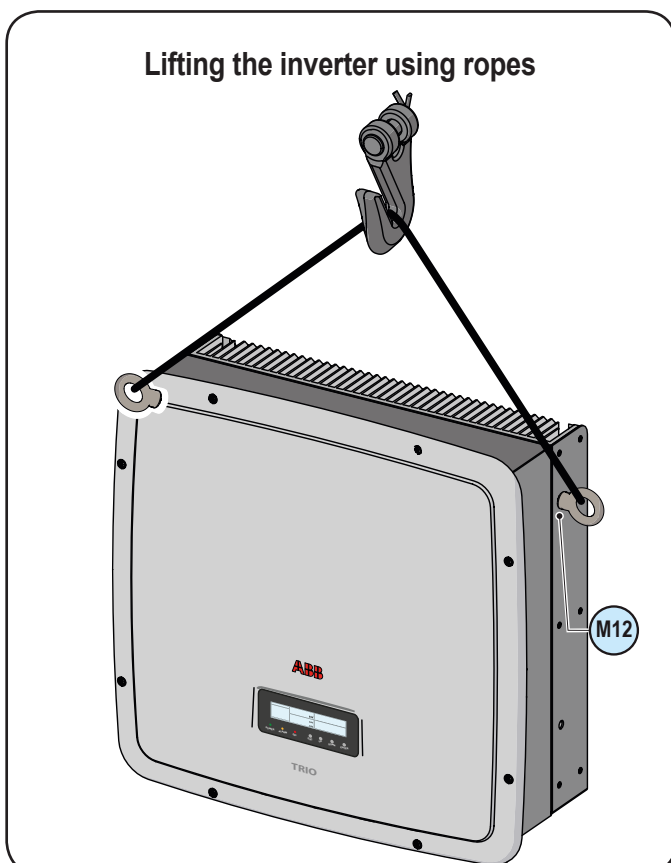
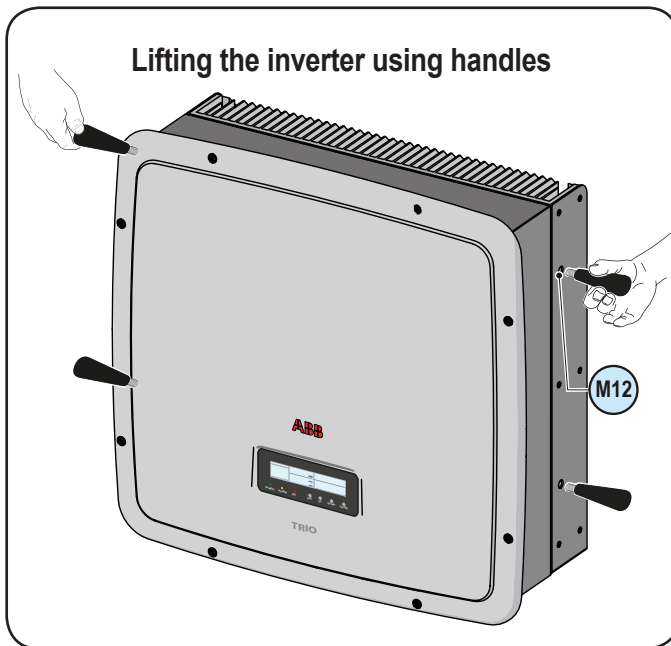

General conditions

Installation of the equipment is carried out based on the system and the place in which the equipment is installed; therefore, its performance depends on the correctness of the connections.

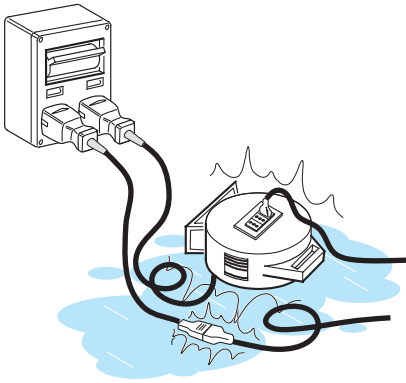

Staff authorised to carry out the installation must be specialised and experienced in this job; they must also have received suitable training on equipment of this type.

The operation must be carried out by specialised staff; it is in any case advisable to comply with what is written in this manual and adhere to the diagrams and attached documentation.



For Safety reason only a qualified electrician, who has received training and / or has demonstrated skills and knowledge in construction and in operation of this unit, can install this inverter.



The installation is done by qualified installers and/or licensed electrician according to the applicable local code regulations



The connection of an inverter energy system to an electrical installation connected to the electricity distribution network shall be approved by the appropriate electrical distributor.



The installation must be carried out with the equipment disconnected from the grid and from the photovoltaic generator.



When the photovoltaic panels are exposed to light, these supplies a direct current voltage to the inverter.

Environmental checks

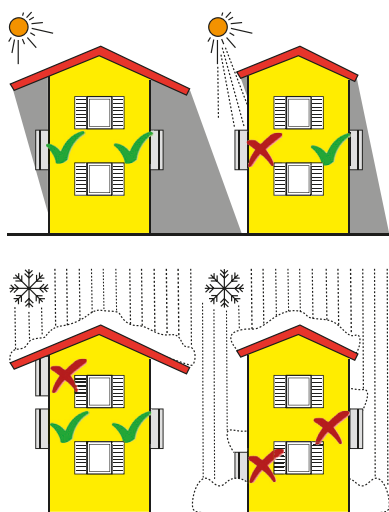

- Consult the technical data to check the environmental parameters to be observed (degree of protection, temperature, humidity, altitude, etc.)
- The installation to direct sunlight must be avoided because it may cause:
 - phenomena of power limitation by the inverter (with consequent reduction of energy production)
 - premature aging of electronic/electromechanical components
 - premature aging of mechanical components (gaskets) and user interface (display)
- Do not install in small closed rooms where air cannot circulate freely.
- To avoid overheating, always make sure the flow of air around the inverter is not blocked.
- Do not install in places where gases or flammable substances may be present.
- Do not install in rooms where people live or where the prolonged presence of people or animals is expected, because of the noise (about 50dB(A) at 1 m) that the inverter makes during operation.
- Avoid electromagnetic interference that can compromise the correct operation of electronic equipment, with consequent situations of danger.



The final installation of the inverter should not prevent access to any outside disconnection means.

Refer to the warranty conditions to evaluate the possible exclusions from warranty related to improper installation.

Installations above 2000 metres

On account of the rarefaction of the air (at high altitudes), particular conditions may occur that should be considered when choosing the place of installation:



- Less efficient cooling and therefore a greater likelihood of the device going into derating because of high internal temperatures.
- Reduction in the dielectric resistance of the air that, in the presence of high operating voltages (DC input), can create electric arcs (discharges) that can reach the point of damaging the inverter.

As the altitude increases, the failure rate of some electronic components increases exponentially because of cosmic radiation.



All installations at altitudes of over 2000 metres must be assessed case by case considering the aforesaid criticalities.

Installation position

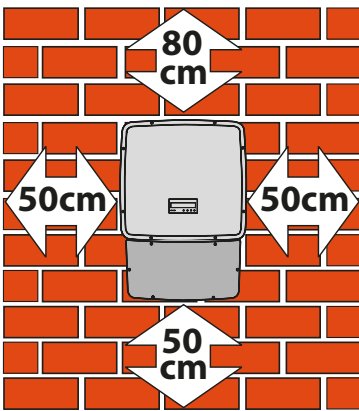
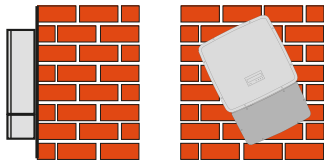
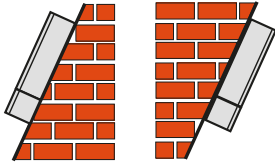

When choosing the place of installation, comply with the following conditions:

- Install on a wall or strong structure suitable for bearing the weight.
- Install in safe, easy to reach places.
- If possible, install at eye-level so that the display and status LEDs can be seen easily.
- Install at a height that considers the heaviness of the equipment. If this condition is not complied with, it can create problems in the event of servicing unless suitable means are provided to carry out the operation.
- Install vertically with a maximum inclination of $\pm 5^\circ$. If this condition is not complied with, the inverter could go into temperature derating because of the worsening of heat dissipation.

- To carry out maintenance of the hardware and software of the equipment, remove the covers on the front. Check that there are the correct safety distances for the installation that will allow the normal control and maintenance operations to be carried out.
- Comply with the indicated minimum distances.

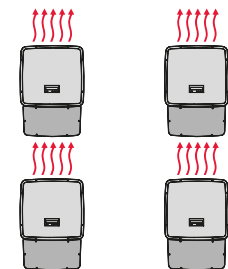
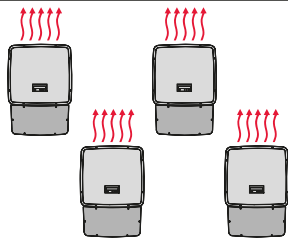
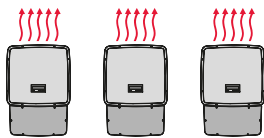

- For a multiple installation, position the inverters side by side.

- If the space available does not allow this arrangement, position the inverters in a staggered arrangement as shown in the figure so that heat dissipation is not affected by other inverters.

Wall mounting

- Position the bracket ① perfectly level on the wall and use it as a drilling template.
- Drill the 10 holes ② required using a drill with 10mm bit. The holes must be about 70mm deep.
- Fix the bracket to the wall with the 10 wall anchors, 10mm in diameter, supplied.

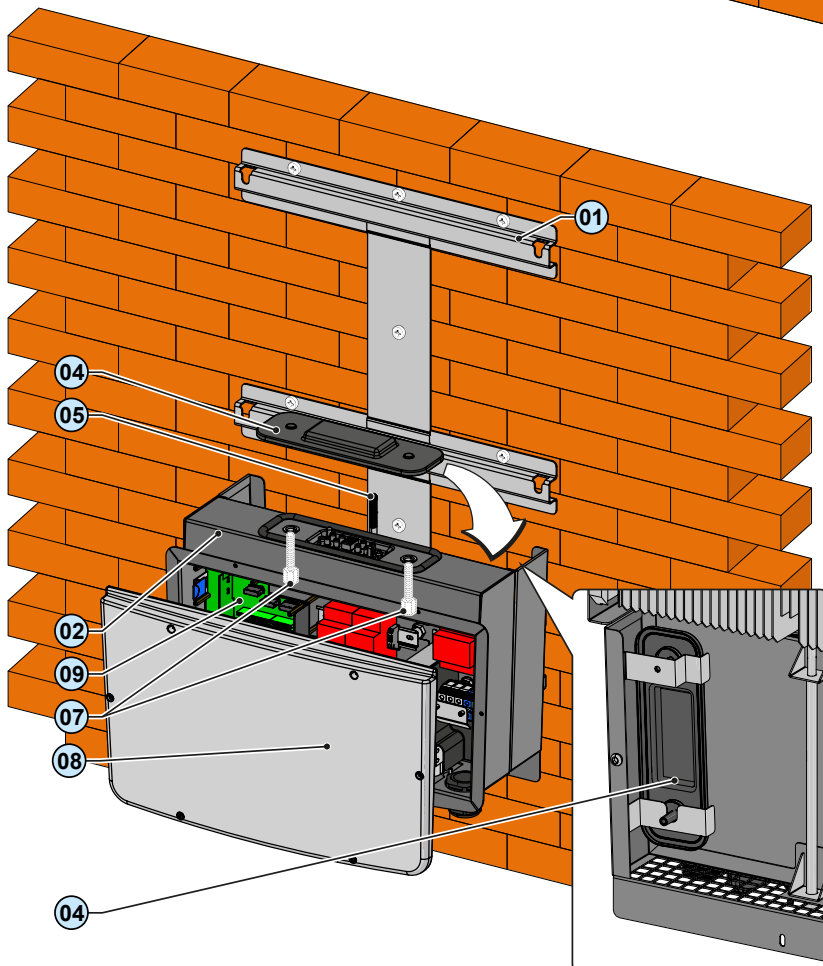
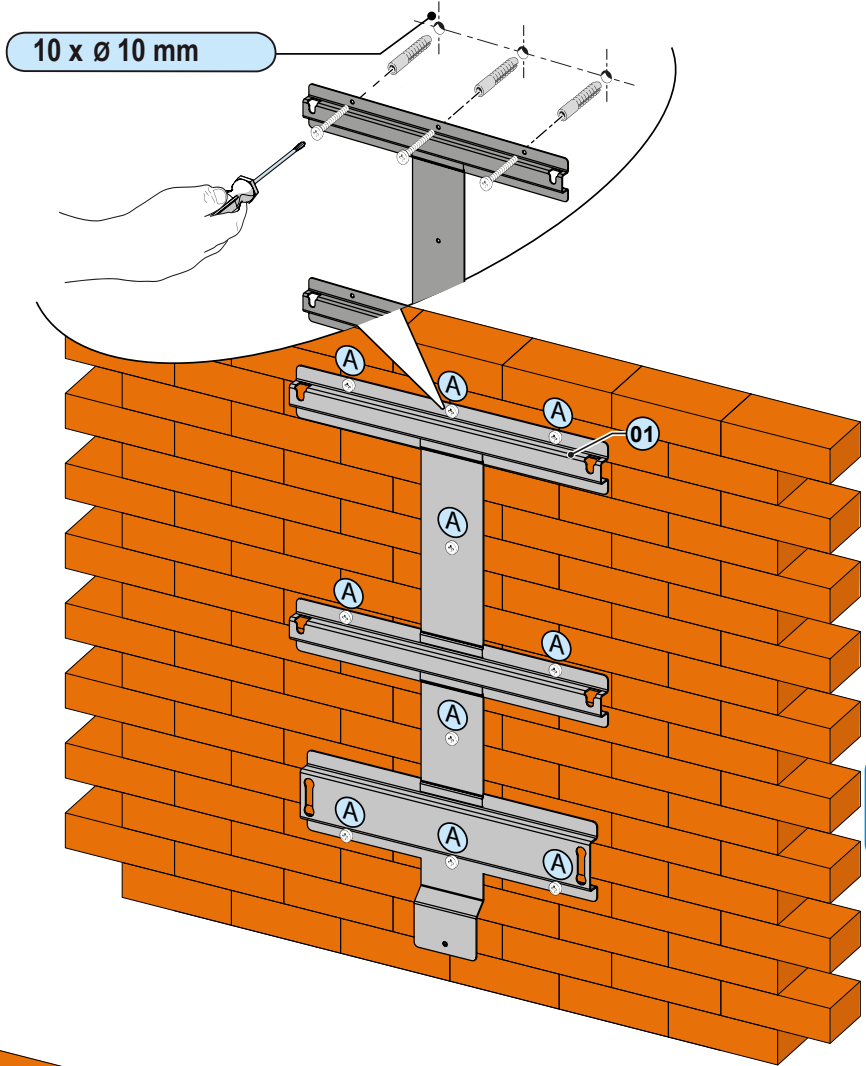

- Hook on the wiring box ② by inserting the head of the rear screws in the slots in the bracket, remove the front cover and make all the necessary connections.

N.B. It is not necessary to install the inverter ③ at this stage.

- Unscrew the connector screws ⑦ and remove the cover ④ so that you can reach the connector between the wiring box and the inverter. Put the cover in the special pocket provided at the back of the wiring box.

- Hook the inverter to the bracket by inserting the head of the rear screws in the slots as shown in the figure. To make lifting easier, handles ⑥ or eyebolts (M12) can be attached to the side holes provided.

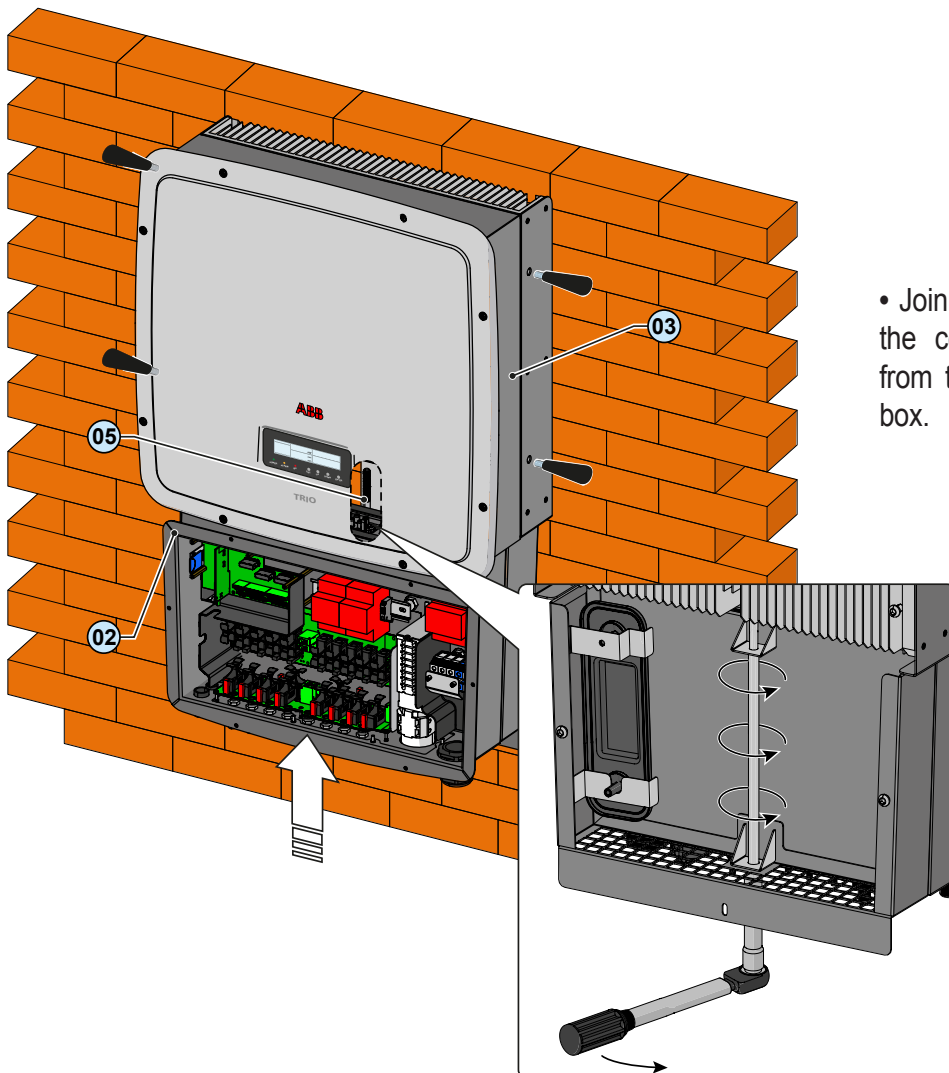
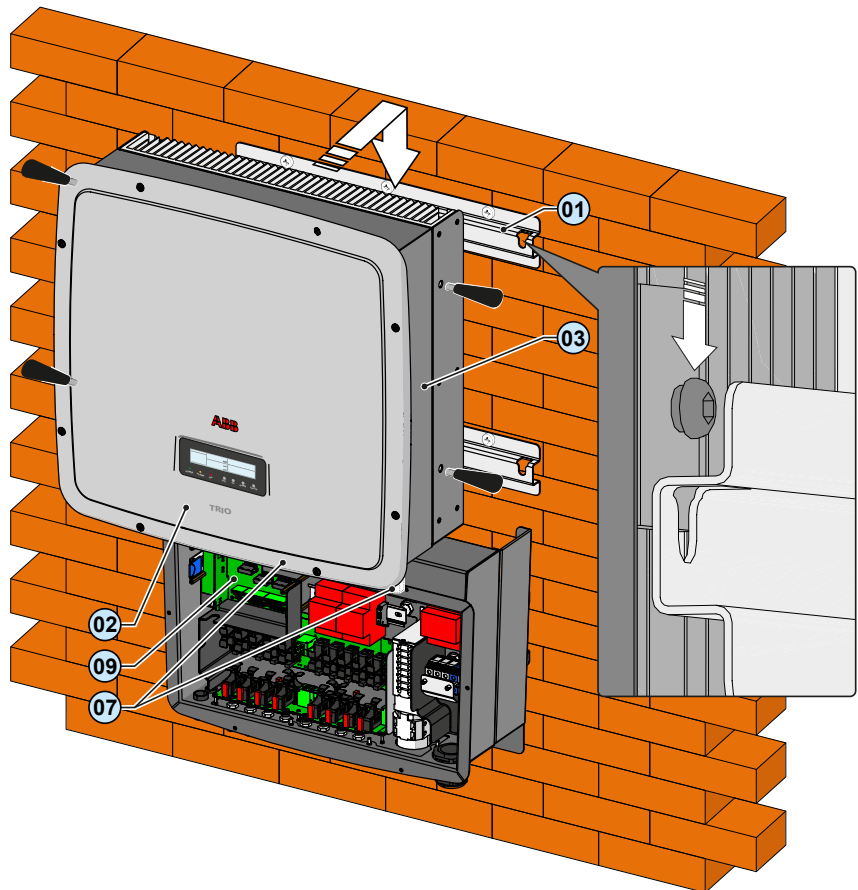

- Join the two parts by tightening the coupling screw ⑤ working from the lower part of the wiring box.

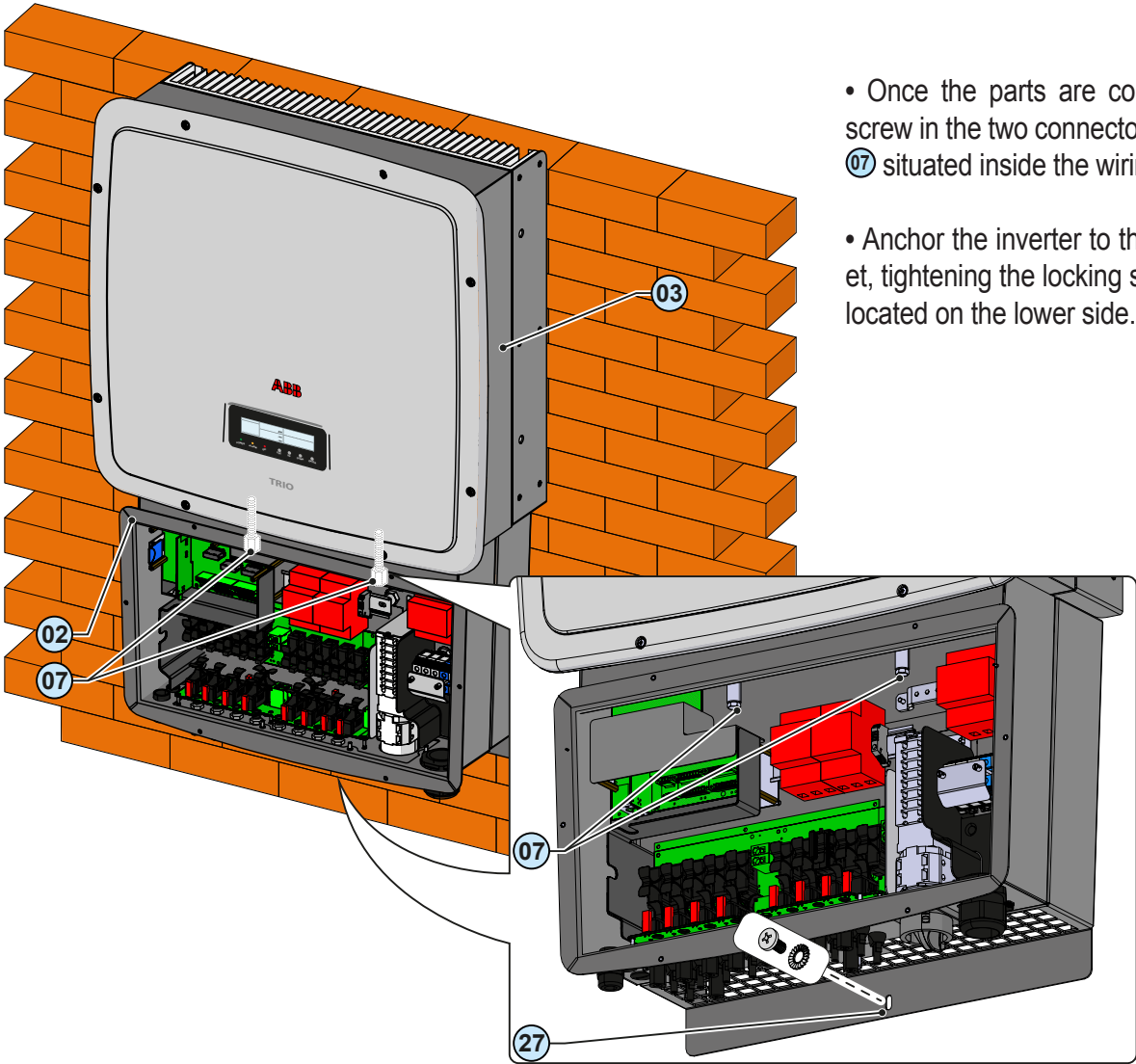

- Once the parts are connected, screw in the two connector screws 07 situated inside the wiring box.
- Anchor the inverter to the bracket, tightening the locking screw 27 located on the lower side.



Operations preparatory to PV generator connection

Checking the correct polarity of the strings

Using a voltmeter, check that the voltage of each string observes the correct polarity and falls within the input voltage limits accepted by the inverter (see technical data).



Inversion polarity can cause serious damage

If the voltage without load of the string is near the maximum value accepted by the inverter, it must be borne in mind that with low ambient temperatures the string voltage tends to increase (in a different way according to the photovoltaic module used). In this case, it is necessary to carry out a check of the sizing of the system and/or a check on the connections of the modules of the system (e.g.: number of modules in series higher than the design number).

Checking of leakage to ground of the photovoltaic generator

Measure the voltage present between positive and negative pole of each string with respect to ground.

If a voltage is measured between an input pole and ground, it may be that there is a low insulation resistance of the photovoltaic generator and the installer will have to carry out a check to solve the problem.



Do not connect the strings if a leakage to ground has been found because the inverter might not connect to the grid.

Choice of differential protection downstream of the inverter

All ABB string inverters marketed in Europe are equipped with a device for protection against ground faults in accordance with the safety standard set in Germany by Standard VDE V 0126-1-1:2006-02 (please refer to section 4.7 of the Standard).

In particular, ABB inverters are equipped with a redundancy on the reading of the ground leakage current sensitive to all components of both direct and alternating current. Measurement of the ground leakage current is carried out at the same time and independently by 2 different processors: it is sufficient for one of the two to detect an anomaly to trip the protection, with consequent separation from the grid and stopping of the conversion process.

There is an absolute threshold of 300 mA of total leakage current AC+DC with protection tripping time at a max. of 300 msec.

In addition, there are another three tripping levels with thresholds respectively at 30 mA/sec, 60 mA/sec and 150 mA/sec to cover the "rapid" changes in fault current induced by accidental contact with leaking live

parts. The max. tripping times are progressively shortened as the speed of change in the fault current increases and, starting from the 300 msec/max for the 30 mA/sec change, they are shortened respectively to 150 msec and 40 msec for 60 mA and 150 mA changes.

It should in any case be noted that the integrated device only protects the system against ground faults that occur upstream of the AC terminals of the inverter (namely towards the DC side of the photovoltaic system and consequently towards the photovoltaic modules). The leakage currents that can occur in the AC section between the draw/feed in point and the inverter are not detected and require an external protection device.

For protection of the AC line, on the basis of the aforesaid with regard to the differential protection integrated in ABB inverters, **it is not necessary to install a type B ground fault interrupter.**



In accordance with article 712.413.1.1.1.2 of Section 712 of IEC Standard 64-8/7, we hereby declare that, because of their construction, ABB inverters do not inject ground fault direct currents.



The use of an AC type circuit breaker with differential thermal magnetic protection with tripping current of 300 mA is advisable so as to prevent false tripping, due to the normal capacitive leakage current of photovoltaic modules.

In the case of systems consisting of multiple inverters connected to a single switch with differential protection, it is recommended to install a device that allows the adjustment of the trip value and timing of intervention.



Independent or parallel input channels configuration

All versions of the inverter are equipped with two input channels (therefore with double maximum power point tracker MPPT) independent of each other, which can however be connected in parallel using a single MPPT.

Strings of photovoltaic modules having the same type and number of panels in series must be connected to each single channel; they must also have the same installation conditions (in terms of orientation to the SOUTH and inclination from the horizontal plane).

When connecting the two input channels in parallel, the aforesaid requirements must be observed with the benefit of being able to use the full power that can be supplied by the inverter on a single channel.

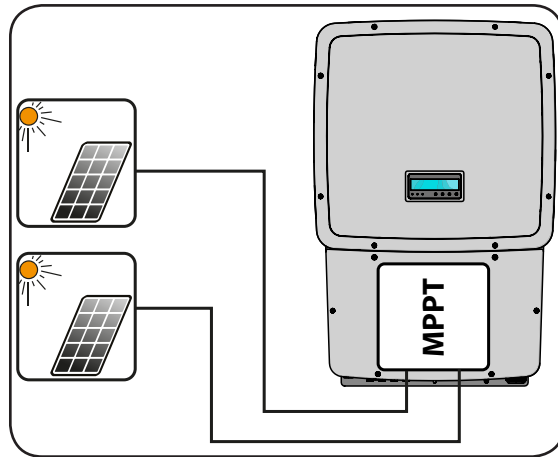

Whereas the double MPPT structure allows the management of two photovoltaic generators that are independent of each other (one for each input channel) and can differ from each other in installation conditions, type and number of photovoltaic modules connected in series. A necessary condition so that the two MPPTs can be used in independent mode is for the photovoltaic generator connected to each of the inputs to have a power lower than the power limit of the single input channel and a maximum current lower than the current limit of the single input channel.

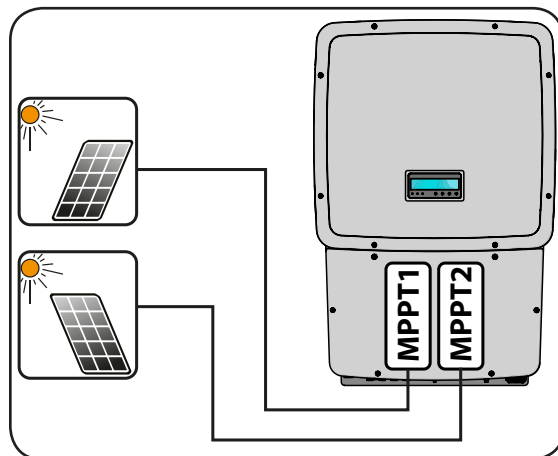

All the input parameters that must be observed for correct operation of the inverter are shown in the “technical data” table.

Channel configuration examples

PV generator characteristics	MPPT configuration	Notes
<p>The photovoltaic generator consists of strings having a different number of modules in series from each other.</p> <p>The photovoltaic generator consists of strings that have different installation conditions from each other.</p>	<p>MPPT configuration has to be INDEPENDENT</p>	<p>A NECESSARY condition so that the two MPPTs can be used in independent mode is for the photovoltaic generator connected to each of the inputs to have a power lower than the power limit of the single input channel AND a maximum current lower than the current limit of the single input channel.</p>
<p>The photovoltaic generator consists of strings having the same number of modules in series as each other.</p> <p>The photovoltaic generator consists of strings that have the same installation conditions, that is to say, all the strings have the same inclination from the horizontal and the same orientation to the SOUTH.</p> <p>The photovoltaic generator connected to each of the inputs has a power lower than the power limit of the input channel AND a current lower than the current limit of the input channel.</p>	<p>Possibility of choosing between the configuration with MPPT as INDEPENDENT or PARALLEL</p>	<p>A NECESSARY condition so that the two MPPTs can be used in independent mode is for the photovoltaic generator connected to each of the inputs to have a power lower than the power limit of the input channel AND a maximum current lower than the current limit of the input channel.</p> <p>An ADVISABLE (*) condition so that the two MPPTs can be connected in parallel is for the photovoltaic generator connected to the two inputs to consist of strings made by the same number of modules in series and for all the modules to have the same installation conditions.</p>
<p>(*) <i>This condition is advisable from the point of view of the energy production of the system, not from the point of view of inverter operation.</i></p>		
<p>The photovoltaic generator consists of strings having the same number of modules in series as each other.</p> <p>The photovoltaic generator consists of strings that have the same installation conditions, that is to say, all the strings have the same inclination from the horizontal and the same orientation to the SOUTH.</p> <p>The photovoltaic generator connected to each of the inputs has a power higher than the power limit of the input channel OR a current higher than the current limit of the input channel.</p>	<p>MPPT configuration has to be PARALLEL</p>	<p>A SUFFICIENT (*) condition so that the two MPPTs must be used in parallel mode is for the photovoltaic generator connected to each of the inputs to have a power higher than the power limit of the single input channel OR a maximum current higher than the current limit of the single input channel.</p> <p>An ADVISABLE (**) condition so that the two MPPTs can be connected in parallel is for the photovoltaic generator connected to the two inputs to consist of strings made by the same number of modules in series and for all the modules to have the same installation conditions.</p>
<p>(*) <i>This condition is sufficient from the point of view of the energy production of the system, not from the point of view of inverter operation.</i></p> <p>(**) <i>This condition is advisable from the point of view of the energy production of the system, not from the point of view of inverter operation.</i></p>		



Configuration of independent channels (default configuration)

This configuration involves the use of the two input channels (MPPT) in independent mode. This means that the jumpers ⑫ between the two channels (positive and negative) of the DC input terminal board ⑬ **must not be installed** and that the switch a01 situated on the communication card ⑨ must be set to “IND” (see user interface).

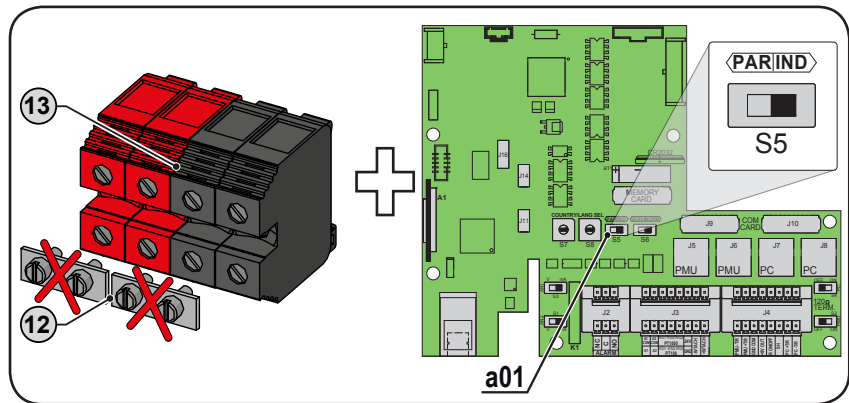

Configuration of parallel-connected channels

This configuration involves the use of the two input channels (MPPT) connected in parallel. This means that the jumpers ⑬ between the two channels (positive and negative) of the DC input terminal board ⑫ **must be installed** and that the switch a01 situated on the communication card ⑨ must be set to “PAR” (see user interface).

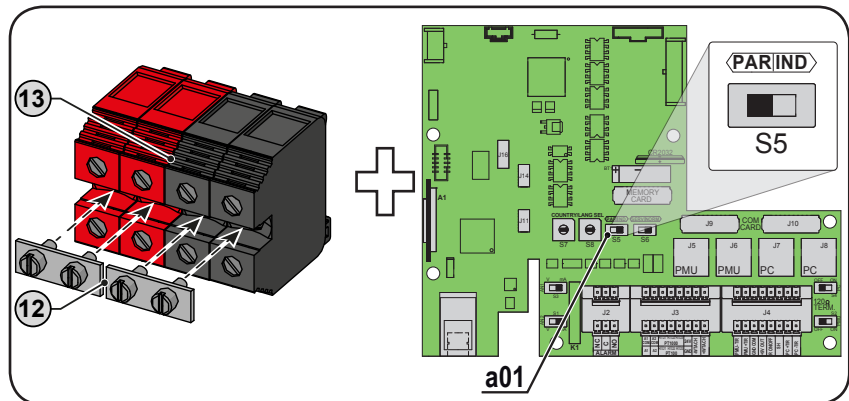

Input connection to the PV generator (DC side)

Once the preliminary checks have been made and it has therefore been verified that there are no problems on the photovoltaic system, and once the channel configuration has been chosen (parallel or independent), the inputs can be connected to the inverter.

The connections can also be made with the wiring box ⑫ detached from the inverter ⑬ that can be connected later for commissioning.

When working with the wiring box ⑫ detached, pay particular attention to outdoor installations, where the coupling connector must always be protected by installing the cover ⑭ on its housing.

The DC side connections are different according to the wiring box used: The basic and S2 models use cable glands whereas the S2F /S2X models uses quick fit connectors (one for each pole of each string).

On the basic and S2 versions, the connection in parallel of the strings (array composition) must take place upstream of the input in the inverter and must be made by technicians during installation.

The S2F / S2X version accepts direct connection of the single strings, with connectors accessible from the outside of the wiring box ⑫.



To prevent electrocution hazards, all the connection operations must be carried out with the AC+DC disconnect switch ⑭ open and locked.



Connection of inputs on the Standard and S2 models

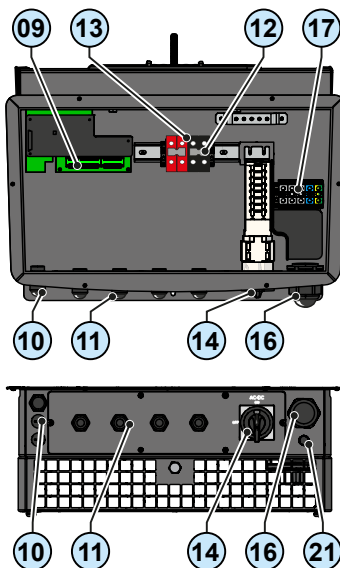

For these two models, connection with the DC input terminal board ⑬ is made by inserting the cables in the DC cable glands ⑪.

The maximum accepted cable cross-section ranges from 10 to 17 mm, whereas each individual terminal of the terminal board accepts a cable with cross-section of up to 50 mm².

Unscrew the cable gland, remove the cover, insert the cable of suitable cross-section and connect it to the terminals on the DC input terminal board ⑬.

Once the connection to the terminal board is complete, screw in the cable gland firmly and check the tightness.



The DC input terminal block ⑬ accepts connection of copper cables. If aluminium cables are used, bimetallic cable terminals of a suitable type must be used to connect the aluminium cables to the contacts in the DC input terminal block ⑬.

Connection of inputs on the S2F / S2X model

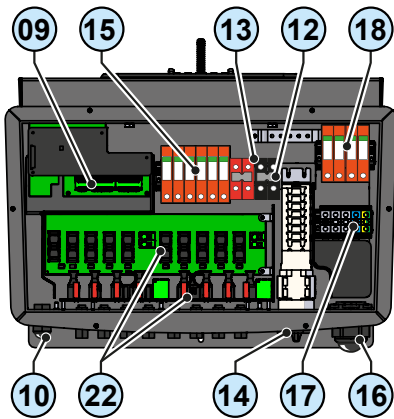

TRIO-20.0kW (S2F/S2X)

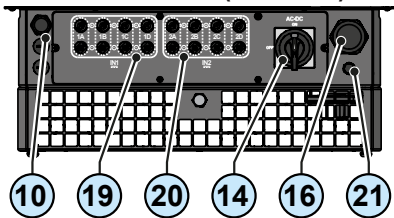

TRIO-27.6kW (S2F/S2X)

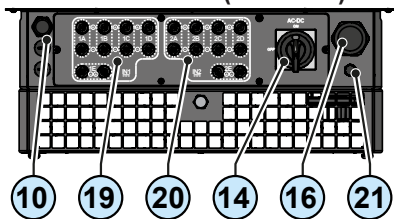

For string connections using the S2F / S2X wiring box, the quick fit connectors (multicontact or weidmuller) situated at the bottom of the mechanism are used.

For each input channel, there are two groups of connectors:

- Input connectors (MPPT1) ⑰ with codes 1A, 1B, 1C, ...
- Input connectors (MPPT2) ⑱ with codes 2A, 2B, 2C, ...

Connect all the strings included in the design of the system and always check the tightness of the connectors.

The number of connections for each input channel varies according to the inverter power size:

TRIO-20.0 - 4 pairs of connectors for each output channel

TRIO-27.6 - 5 pairs of connectors for each output channel

If some string inputs are not used, check that there are covers on the connectors and install them if they are missing.

This operation is necessary for the tightness of the inverter and to avoid damaging the free connector that could be used at a later date.



IP65

In these versions of the wiring box, you MUST directly connect the individual strings coming into the inverter (do not make field switchboards for parallel strings). This is because the string fuses ⑳, situated on each input, are not sized to take strings in parallel (array). This operation can cause damage to the fuse and consequently malfunctioning of the inverter.

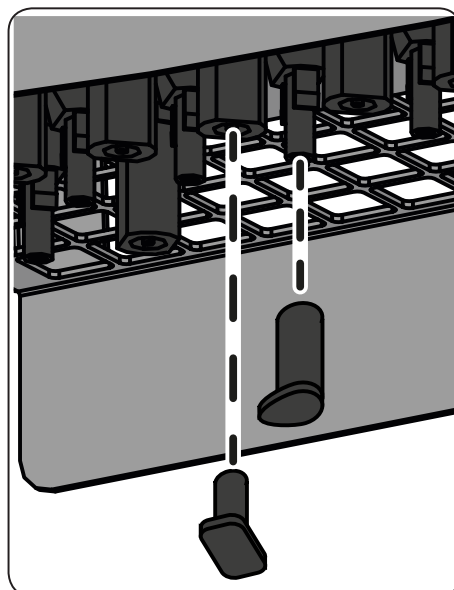

Installation procedure for quick fit connectors

On inverter models with which quick fit connectors are supplied, they may be supplied in two different types:



CAUTION: To avoid damage to the equipment, when attaching cables, pay particular attention to polarity.

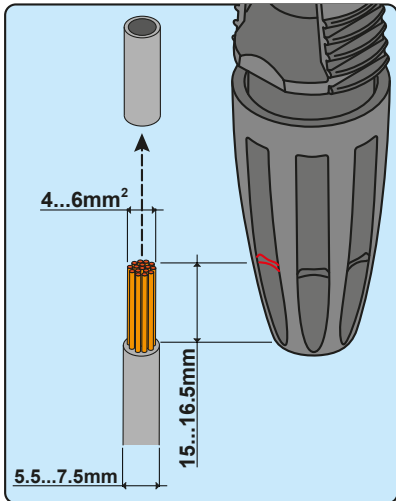

Weidmüller

Installation of Weidmüller connectors does not require any special tooling.

- Strip the cable to which you want to apply the connector (after verifying that it complies with the connector limits)

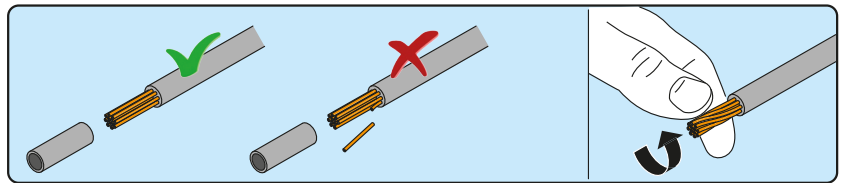

- Insert the wire into the connector until you hear a locking “click”

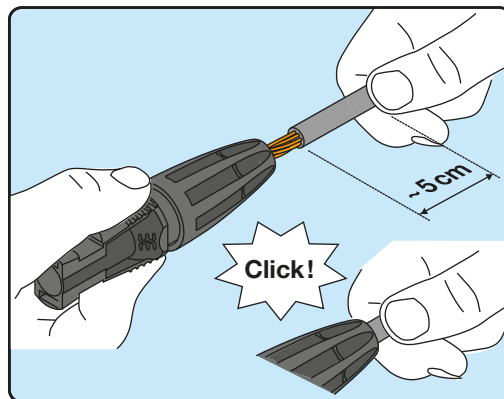

- Tighten the knurled ring nut for optimal clamping

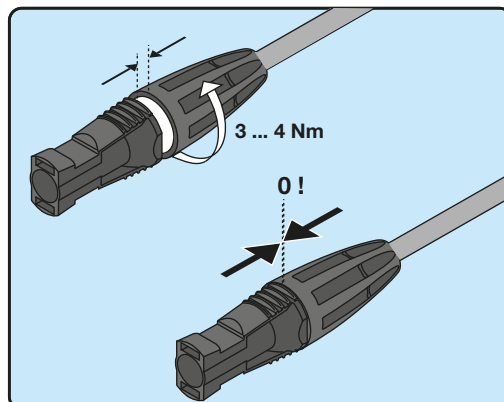

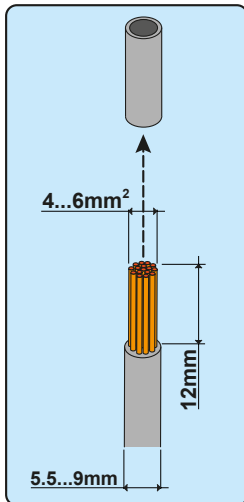

MULTICONTACT (or equivalents)

Installation of Multicontact connectors requires crimping to be carried out with suitable equipment.

- Strip the cable to which you want to apply the connector (after verifying that it complies with the connector limits)

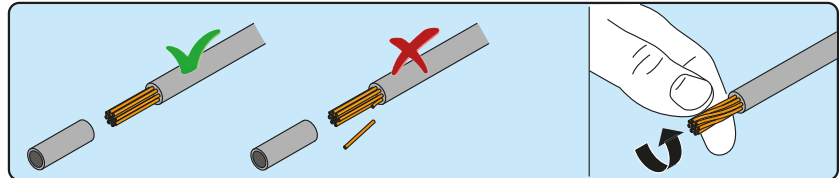

- Apply the terminal to the conductor using suitable crimping pliers

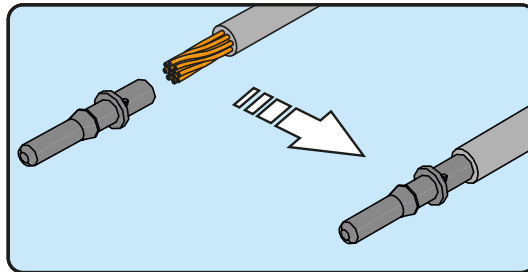

- Insert the cable with the terminal into the interior of the connector, until you hear the click indicating that the terminal is locked inside the connector.

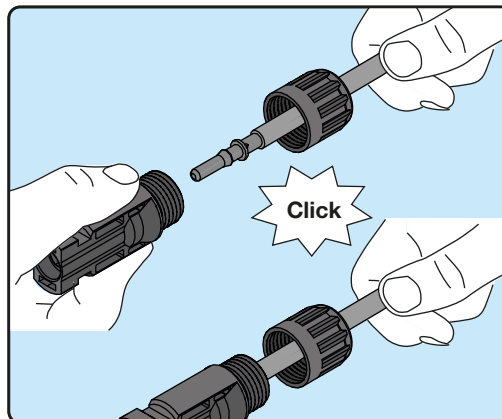

- Firmly tighten the cable gland to finish the operation

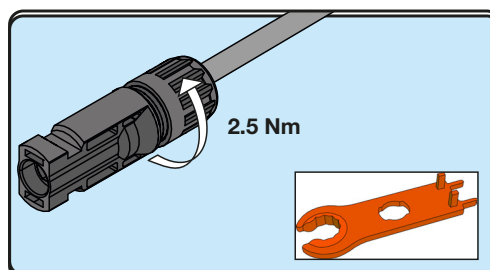

String protection fuses (-S2F / S2X models only)

Sizing of fuses

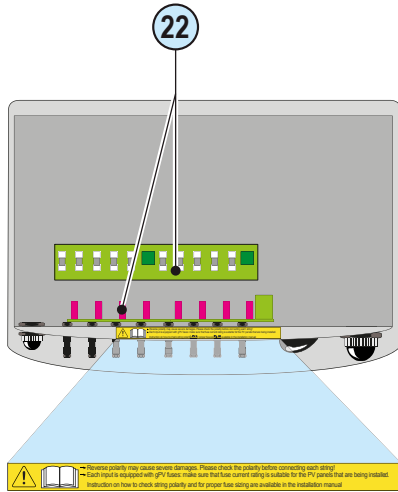

Correctly sizing the string fuses ②② to be used for protection against return currents is very important since it can significantly reduce the risk of fire and damage to the PV generator. A “return current” can be generated in the event of a fault and relevant short-circuit at the ends of one or more PV modules of the system; this condition can cause all the current supplied by the strings not involved in the fault, but connected to the same input channel, to pass through the faulty string.

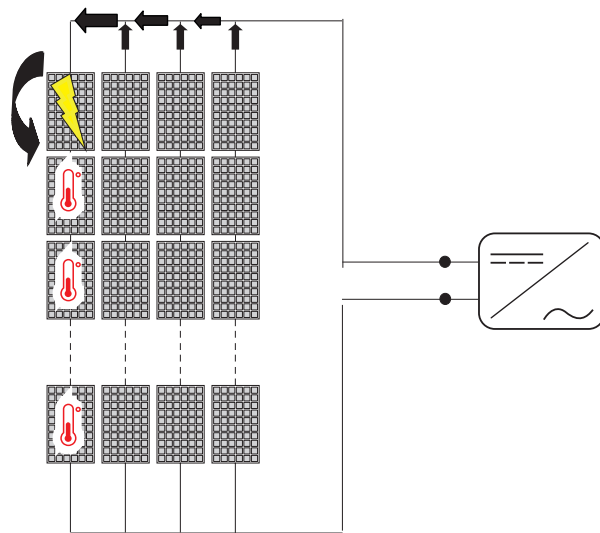

The following 2 conditions must be taken into account when sizing the string fuses ②②:

1. The current rating of the fuse (I_{rated}) may not exceed the maximum rating of the fuse to be used in series with the string (maximum series fuse rating), specified in the technical data of the PV modules, in agreement with standard IEC 61730-2

$$I_{rated} < \text{Maximum series fuse rating}$$

2. The rating of the fuse (I_{rated}) must be determined according to the string current and the manufacturer's sizing guidelines in order to avoid unforeseen failures. As a general guide, based on the short-circuit current (I_{sc}) of the PV modules, the fuse rating may be calculated from the following formula:

$$I_{rated} > (1.4 \approx 1.5) \cdot I_{sc}$$

The fuse selected must be the standard commercial size closest to the result obtained.

The fuse selected according to the formula described above must take into account adjustments and derating factors such as:

- Increase in the effective incident radiation at the installation site
- Increase in I_{sc} as a result of high temperature in the PV module
- Thermal derating of the fuse
- Maximum return current of the installed PV modules

ABB can supply fuse kits of different values

Code	Description	Quantity
KIT 10 FUSES 8A	Kit of 8A fuses	10
KIT 10 FUSES 10A	Kit of 10A fuses	10
KIT 10 FUSES 12A	Kit of 12A fuses	10
KIT 10 FUSES 15A	Kit of 15A fuses	10



For effective calculation taking real installation conditions into account, refer to the documents supplied by the fuse manufacturer.



Grid output connection (AC side)

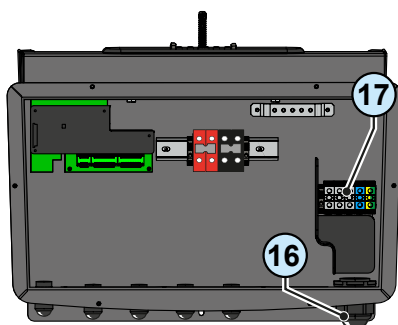

For the connection of the inverter to the grid, you can choose between a star connection (3 phases + neutral) and a delta connection (3 phases). In any case, connection of the inverter to ground is mandatory.

The cable you use can be 5-pole (star configuration) or 4-pole (delta configuration) and must pass through the AC cable gland (16) to make the connections to the AC output terminal board (17).

The connections can also be made with the wiring box (02) detached from the inverter (03) that can be connected later to be put in service.

When working with the wiring box (02) detached, pay particular attention to outdoor installations, where the coupling connector must always be protected by installing the cover (04) on its housing.

Characteristics and sizing of the protective earthing cable

ABB inverters must be earthed via the terminal with the protective earth symbol (⊕), using a cable with an appropriate conductor cross-section for the maximum ground fault current that the generating system might experience.



Any failure of the inverter when it is not connected to earth through the appropriate terminal is not covered by the warranty.

In compliance with standard IEC 62109 it is necessary:

- To install a copper earthing cable on the AC output terminal block (17) with a minimum section of 10 mm².

- Alternatively it is possible to install a second earthing cable (with the same section as the one installed on the AC output terminal block (17)) on the connection point located on the underside of the inverter and marked with the symbol ⊕.

Installation of a second protective earthing cable is also required by regulations in force in certain countries of installation.



If necessary, carefully read the instructions provided in the paragraph “Installation of the second protective earthing cable”.

Characteristics and sizing of the line cable

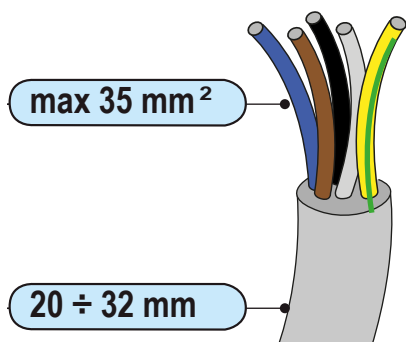

The cross-section of the AC line conductor must be sized in order to prevent unwanted disconnections of the inverter from the grid due to high impedance of the line that connects the inverter to the power supply point; In fact, if the impedance is too high, it causes an increase in the AC voltage that, on reaching the limit set by the country of installation, causes the inverter to switch off.

The table shows the maximum length of the line conductor based on the cross-section of this conductor:

Cross-section of the line conductor (mm ²)	Maximum length of the line conductor (m)	
	TRIO-20.0-TL-OUTD	TRIO-27.6-TL-OUTD
10	42m	30m
16	70m	50m
25	100m	78m
35	138m	98m



The values are calculated in nominal power conditions, considering:

- loss of power along the line no greater than 1%
- use of copper cable, with HEPR rubber insulation and positioned in open air

Load protection switch (AC disconnect switch)

To protect the AC connection line of the inverter, we recommend installing a device for protection against over current and leakage with the following characteristics:

	TRIO-20.0-TL-OUTD	TRIO-27.6-TL-OUTD
Type	Automatic circuit breaker with differential thermal magnetic protection	
Voltage/Current rating	40A/400V	63A/400V
Magnetic protection characteristic	B/C	B/C
Type of differential protection	A/AC	A/AC
Differential sensitivity	300mA	300mA
Number of poles	3/4	3/4

Connection to the AC side terminal board



To prevent electrocution hazards, all the connection operations must be carried out with the disconnect switch downstream of the inverter (grid side) open and locked.
Be careful not to change round one of the phases with neutral!



High leakage current. Grounding is essential before connection to the power supply network.

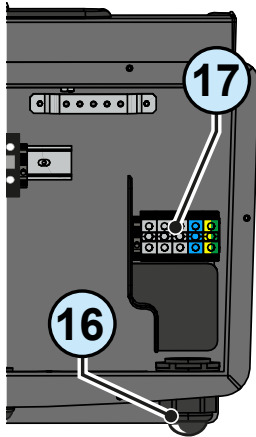

For all models, connection with the AC output terminal board ⑰ is made by inserting the cables in the AC cable gland ⑰.

The maximum accepted cable cross-section ranges from 20 to 32 mm², whereas each individual terminal of the terminal board accepts a cable with cross-section of up to 35 mm².

AC cable installation:

- Unscrew the cable gland and remove the cover
- Enter the appropriate section cable through the AC cable gland
- Connect the conductors Neutral, R, S, T and Protective Earth (⊕) to the terminals on the AC output terminal block ⑰.

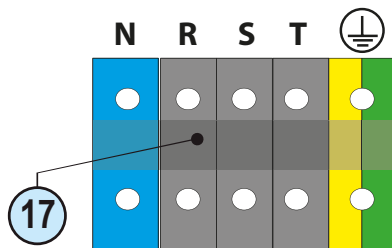

The connection of the inverter to the grid can be with three wires (delta configuration) or with four wires (star configuration).

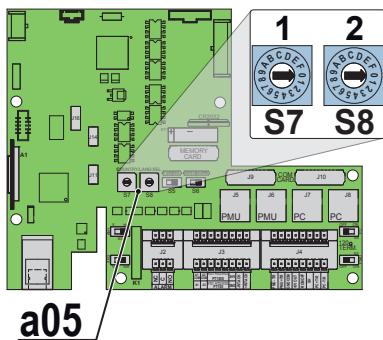

Before connecting the inverter to the national grid, the standard of the country must be set. To do this, turn the two rotary switches **a05** following the table shown in the relevant chapter.

- Once the connection to the terminal board is complete, screw in the cable gland firmly and check the tightness.



The AC output terminal block ⑰ accepts connection of copper cables. If aluminium cables are used, bimetallic cable terminals of a suitable type must be used to connect the aluminium cables to the contacts in the AC output terminal block ⑰.

Installation of the second protective earthing cable

Should it be necessary to install a second protective earthing cable, follow the procedure described below:

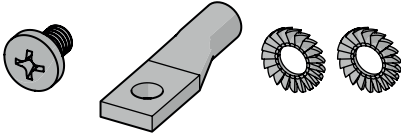

- From among the components supplied, find the M6 screw, the two knurled washers and the cable lug

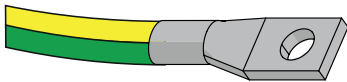

- Fit the cable lug on the protective earthing cable.
The cable lug accepts cables with a cross-section of from 4 to 6 mm²

- Fasten the cable lug using the screw and the two washers, following the sequence illustrated below and tightening to a torque of 4.1 Nm.
The connection point is located on the underside of the inverter.

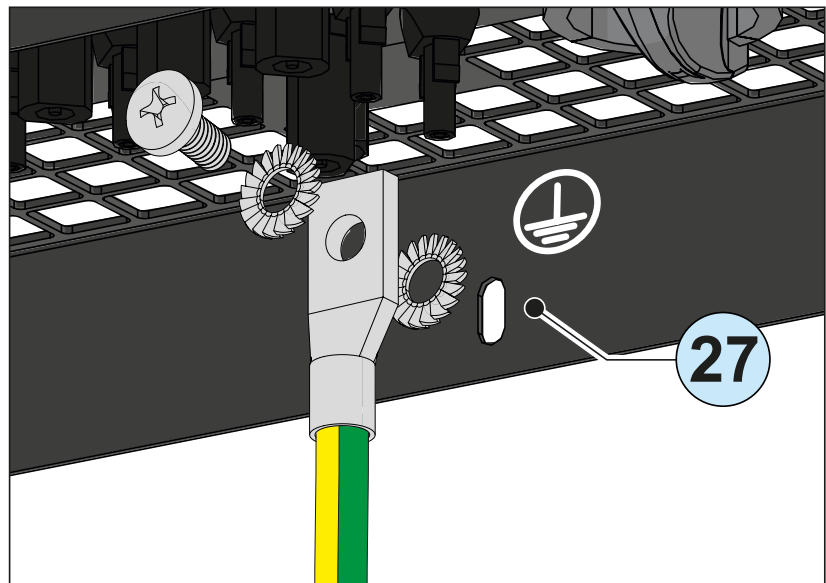

Communication card

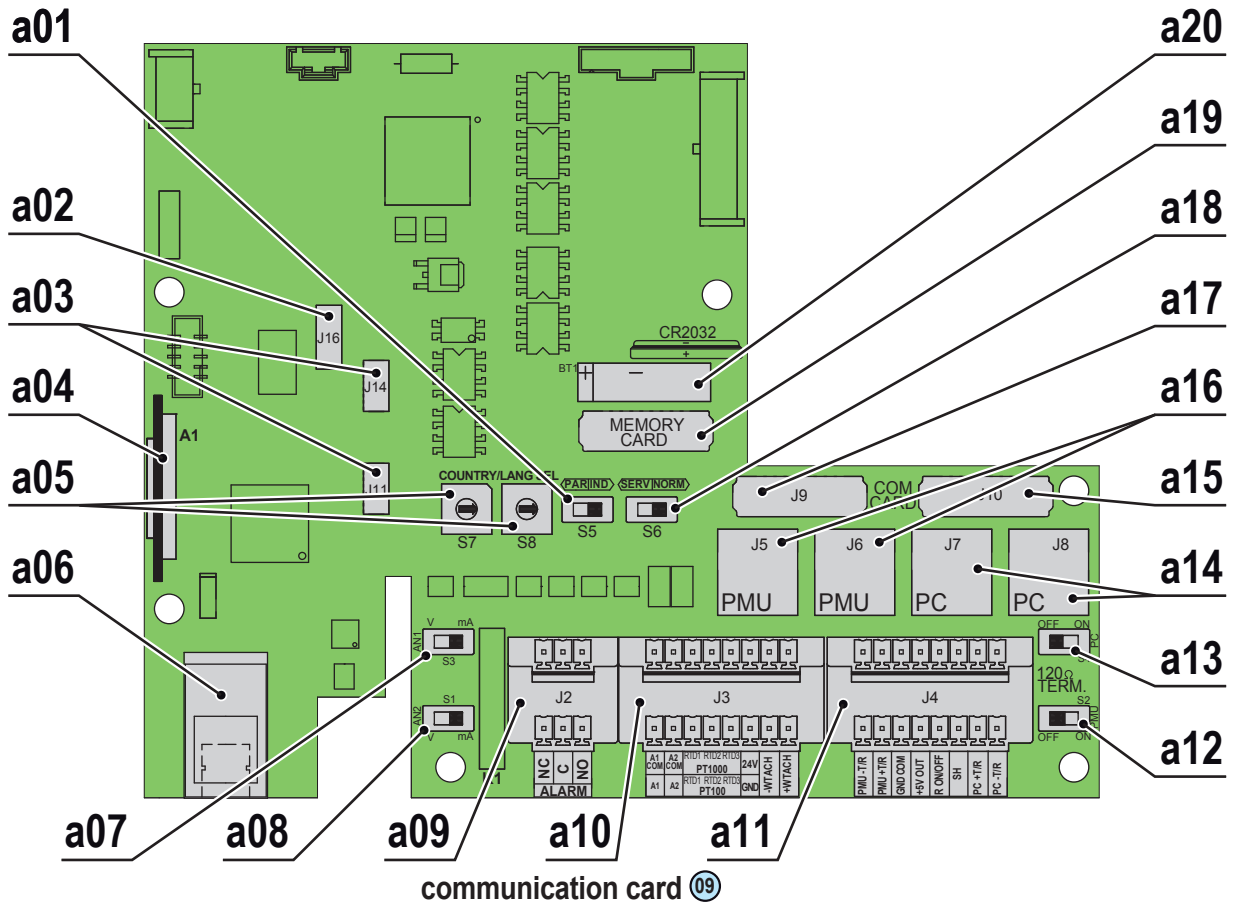

Ref. inverter	Ref. manual	Description
S5	a01	Switch for setting parallel-connected or independent input channels
J16	a02	Connector for the installation of WIFI modules (NOT ACTIVE)
J11 e J14	a03	Connectors for radiomodule card installation
A1	a04	Housing for memory card SD CARD
S7 e S8	a05	Rotary switches for setting the standard of the country and the language of the display
J1	a06	Ethernet port (NOT ACTIVE)
S3	a07	Switch for setting analogue sensor 1 to Volts or mA
S1	a08	Switch for setting analogue sensor 2 to Volts or mA
J2	a09	Connection to the multi-function relay
J3	a10	Connectors for environmental sensors: AN1, AN2, PT100, PT1000, tachymeter (wind version only) and power supply for environmental sensors (24 V DC)
J4	a11	Connection of the RS485 (PC) line, RS485 (PMU) line, of the auxiliary 5V and of the remote ON/OFF
S2	a12	Switch for setting the termination resistance of the RS485 (PMU) line
S4	a13	Switch for setting the termination resistance of the RS485 (PC) line
J7 e J8	a14	Connection of the RS485 (PC) line on RJ45 connector
J10	a15	RS485 (PC) communication card housing
J5 e J6	a16	Connection of the RS485 (PMU) line on RJ45 connector
J9	a17	RS485 (PMU) communication card housing
S6	a18	Switch for setting the inverter in normal or service mode
J12	a19	Inverter data memory card housing
BT1	a20	Battery housing

Connections to the communication card

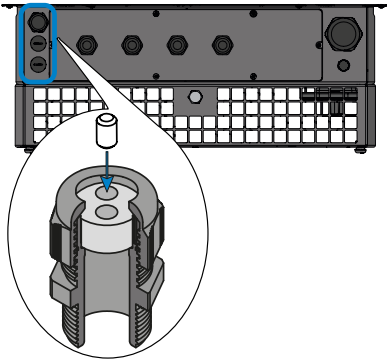

Each cable that must be connected to the communication card ⑨ must go through the three service cable glands ⑩.

- One of size M25 that accepts a cable with cross-section of between 10mm and 17mm. Two-hole gaskets are supplied for insertion in the cable gland, which allow two separate cables with cross-section of up to 6mm to go through.
- Two of size M20 that accept a cable with cross-section of between 7mm and 13mm. Two-hole gaskets are supplied for insertion in the cable gland, which allow two separate cables with cross-section of up to 5mm to go through.

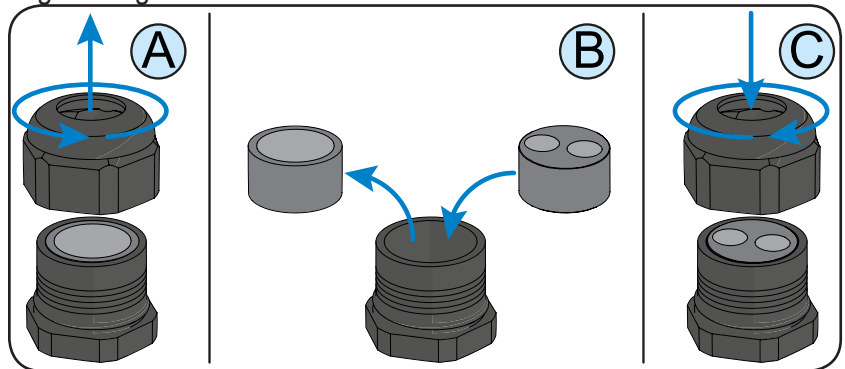

Remote control connection

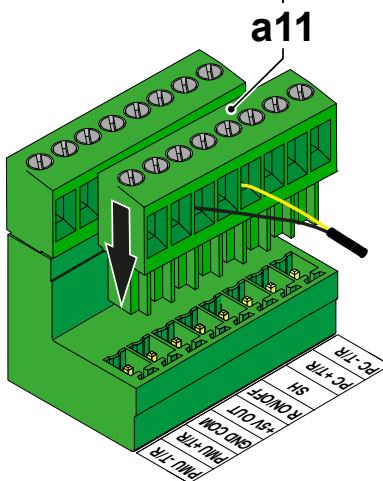
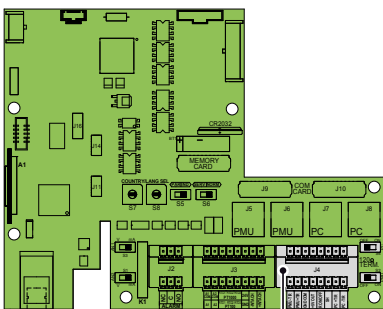
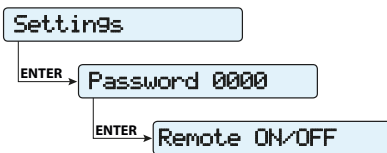

The connection and disconnection of the inverter to and from the grid can be controlled through an external control.

The function must be enabled in the relevant menu. If the remote control function is disabled, the switching on of the inverter is dictated by the presence of the normal parameters that allow the inverter to connect to the grid.

If the remote control function is operating, besides being dictated by the presence of the normal parameters that allow the inverter to connect to the grid, the switching on of the inverter also depends on the state of the R ON/OFF terminal compared to the GND COM terminal present on the connector a11 of the communication card ⑨.

When the R ON/OFF signal is brought to the same potential as the GND COM signal (i.e. by making a short circuit between the two terminals of the connector), this causes the inverter to disconnect from the grid.

The remote control OFF condition is shown on the display.

The connections of this control are made between the “R ON/OFF” input and “GND COM”.

Since this is a digital input, there are no requirements to be observed as regards cable cross-section (it only needs to comply with the sizing requirement for passing cables through the cable glands and the terminal connector).

Configurable Relay connection (ALARM)

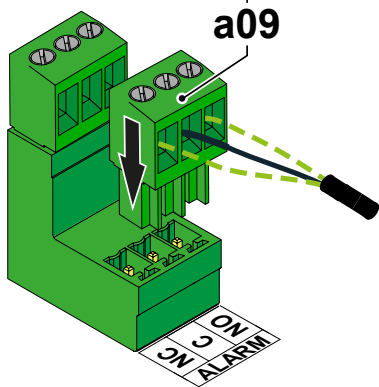
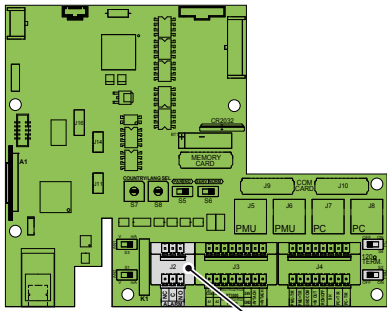

The inverter is equipped with a multifunction relay with configurable activation. It can be connected with normally open contact (being connected between the NO terminal and the common contact C) and with normally closed contact (being connected between the NC terminal and the common contact C).

Different types of devices (light, sound, etc.) can be connected to the relay, provided they comply with the following requirements:

Alternating current

Maximum Voltage: 240 V AC

Maximum Current: 1 A

Direct current

Maximum Voltage: 30 V DC

Maximum Current: 0.8 A

Cable requirements

External diameter: from 5 to 17 mm

Conductor cross-section: from 0.14 to 1.5 mm²

This contact can be used in different operating configurations that can be selected by accessing the “SETTINGS → Alarms” menu. The selectable modes are described in the paragraph on the “Settings Menu”



Connecting environmental sensors

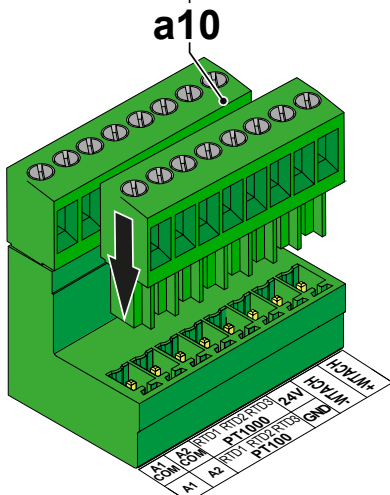
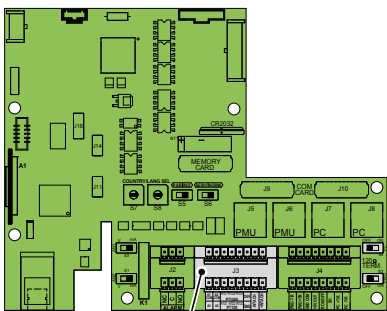

External sensors for monitoring environmental conditions can be connected to the connectors of the environmental sensors a10:
The sensor cables are connected to communication card 09 through the terminal connectors supplied.

AN1 - Analogue sensor 1 connection

AN2 - Analogue sensor 2 connection

PT100 - Connection of a PT100 temperature sensor

PT1000 - Connection of a PT1000 temperature sensor

Setting of the connected analogue sensors must be carried out by setting the following values in the relevant menu:

- GAIN
- OFFSET
- Unit of measure
- Unità di misura

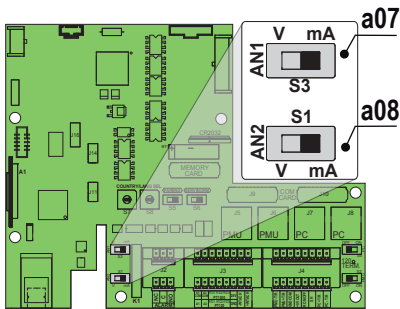

For each analogue sensor, AN1 and AN2, it is also necessary to set the switch, a07 or a08, to select whether the reading is in Volts or mA.



Each sensor model has precise configuration values that must be set meticulously.

If the analogue sensors require an external power supply, use terminals 24V (positive) and GND (negative) on connector a10.

The maximum +24V auxiliary voltage output current is 300mA

Specifications of environmental sensors

Tables with the technical data of the main sensors marketed by ABB are shown below:

Model	Type	Gain	Offset	Unit of Measurement
PVI-AEC-IRR	Irradiation sensor	120	0	W/mq
PVI-AEC-IRR-T	Irradiation sensor with integrated cell temp. sensor	Irradiation: 120 Cell temp.: 10.869	Irradiation: 0 Cell temp.: -20	Irradiation: W/m ² Cell temp.: °C
PVI-AEC-RAD-13TC	Irradiation sensor	130	0	W/m2
PVI-AEC-RAD-13-TC-T	Irradiation sensor with integrated cell temp. sensor	Irradiation: 130 Cell temp.: 11.507	Irradiation: 0 Cell temp.: -26.1	Irradiation: W/m ² Cell temp.: °C
PVI-AEC-CONV-T100	PT100/0...10V converter	15	-50	°C a 0...10V
PVI-AEC-T1000-INTEGR	Ambient temperature sensor with integrated converter	10	-50	°C
PVI-AEC-WIND-COMPACT	Wind speed sensor	5	0	m/s
PVI-AEC-PYR-1300	Pyranometer (0...1300W/m ²)	65	0	W/m ²
PVI-AEC-T100-ADH	Adhesive PT100 module temperature sensor (back cell)	N/A	N/A	N/A
PVI-AEC-T1000-BOX	PT1000 ambient temperature sensor	N/A	N/A	N/A

Model	Output signal	Power supply needed (24Vdc)	TRIO compatibility	20/27.6EVO compatibility
PVI-AEC-IRR	0...10Vdc	YES	YES	YES
PVI-AEC-IRR-T	0...10Vdc	YES	YES	YES
PVI-AEC-RAD-13TC	0...10Vdc	YES	YES	YES
PVI-AEC-RAD-13-TC-T	0...10Vdc	YES	YES	YES
PVI-AEC-CONV-T100	0...10Vdc	YES	YES	YES
PVI-AEC-T1000-INTEGR	0...10Vdc	YES	YES	YES
PVI-AEC-WIND-COMPACT	0...10Vdc	YES	YES	YES
PVI-AEC-PYR-1300	0...20mA	YES	NO	YES
PVI-AEC-T100-ADH	3-wire connection on terminals: RTD1PT100 RTD2PT100 RTD3PT100	NO	YES	YES
PVI-AEC-T1000-BOX	3-wire connection on terminals: RTD1PT1000 RTD2PT1000 RTD3PT1000	NO	YES	YES

Connection diagrams for environmental sensors

Connection diagrams for the main sensors marketed by ABB are shown below: For non-conventional installations or additional information about the connections, please contact the technical support department.

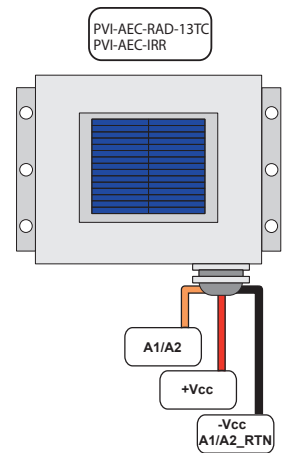
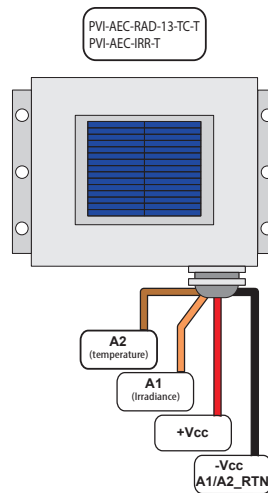
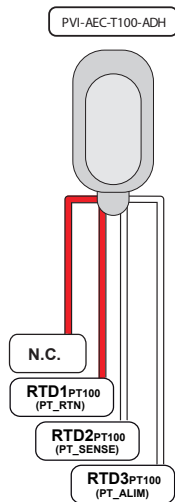
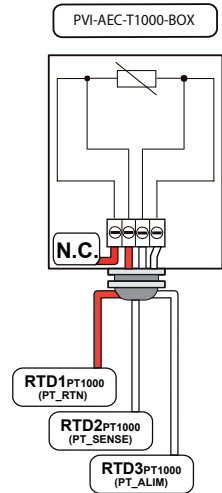
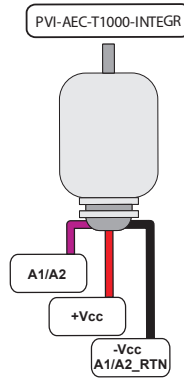
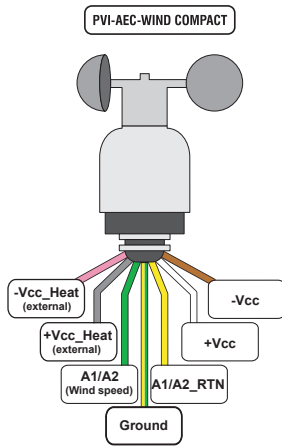

5 V auxiliary output connection

There is an auxiliary 5 V output on connector a11. The maximum allowed absorption by this auxiliary supply voltage is 100 mA.

Serial Communication Connection (RS485)

There are two RS485 communication lines on the inverter:

PC - dedicated line connecting the inverter to monitoring devices which use the proprietary communication protocol "Aurora" or to carry out firmware configuration and update operations using the configuration software "Aurora Manager LITE".

The line can also even accept power management controls.

PMU (power management unit) - dedicated line for the commands used for inverter power management by the power distributor in the country where the inverter is installed or to connect the inverter to monitoring devices that use the "ModBus RTU" communication protocol. The communication protocol can be set up using the display menu "SETTINGS>PMU RS485".

This line must not be used to carry out firmware configuration and update operations using the configuration software "Aurora Manager LITE".

Cables connecting the RS485 line (PC) and RS485 line (PMU) may use two different types of connection:

- **Connection of the conductors using the terminal connectors a11 (+T/R, -T/R, GND COM and SH)**

The LNK connection must be used for connecting the shielding boot(s) of the cable(s).

- **Connessione dei conduttori con connettori RJ45 a12**

The RJ45 connectors (A) and (B) available for the RS485 communication, are equivalent to each other and can be used interchangeably for the arrival or for the output of the line in realising the daisy chain connection of the inverters.

The same is true for connections made using the terminal connectors a11.

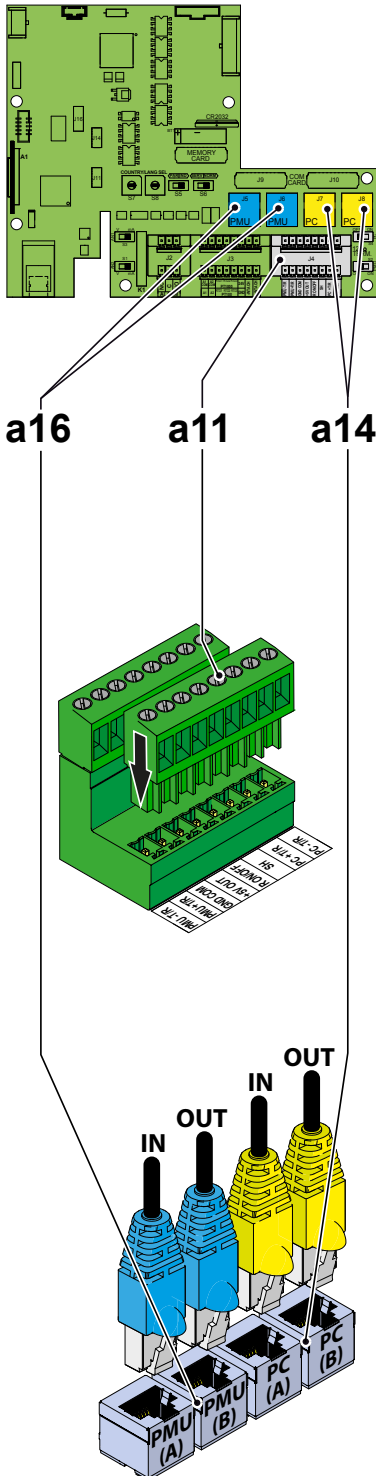
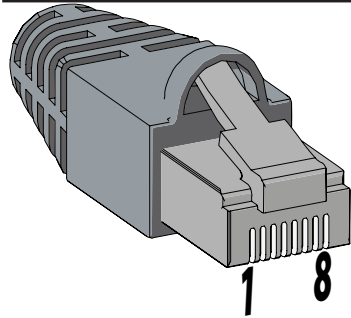

Table: crimping scheme connectors RJ45

Pin N°	Function
3	+T/R
5	-T/R
7	GND COM
1, 2, 4, 6, 8	not used



Use a connector with metal body to provide cable shield continuity!

For long distance connections, the connection on terminal connector is preferable using a shielded twisted pair cable with characteristic impedance of $Z_0=120$ Ohm like the one shown in the following table:

Signal	Symbol
Positive data	+T/R
Negative data	-T/R
Reference	GND COM
Shield	SH

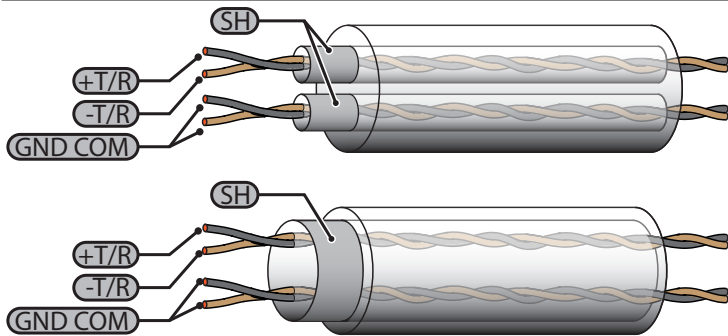

Shield continuity must be provided along the communication line using the SH terminal and must be grounded at a single point.

Monitoring and control systems

The RS485 line can be used to set up a line of communication which, when connected to a monitoring device, enables the operation of the photovoltaic system to be kept under control. Depending on the device used monitoring can be **local or remote**.

Here below are some of the main ABB monitoring devices:

- **Local monitoring**

- **“PVI-USB-RS485_232”** converter and a PC with **“Aurora Communicator”** software installed. It enables complete monitoring of the system
- **PVI-DESKTOP**. It enables the system's main data to be viewed through cabled RS485 communication
- **PVI-DESKTOP** and **PVI-RADIOMODULE**. It enables the system's main data to be viewed through wireless (radio) communication

- **Remote monitoring**

- **PVI-AEC-EVO** and **“AV Plant Viewer” web portal**. It enables the system to be monitored remotely through online access



For information on installation, compatibility and use please refer to the specific documentation on the accessory components.

Procedure for connection to a monitoring system

Connect all the units of the RS485 chain in accordance with the “daisy-chain” arrangement (“in-out”) observing the correspondence between signals, and activate the termination resistance of the communication line in the last element of the chain by switching switch a12 or a13 (to ON position) being careful to switch the switch of the serial line used (PC or PMU).



The communication line must also be terminated on the first element of the chain which normally corresponds to the monitoring device.

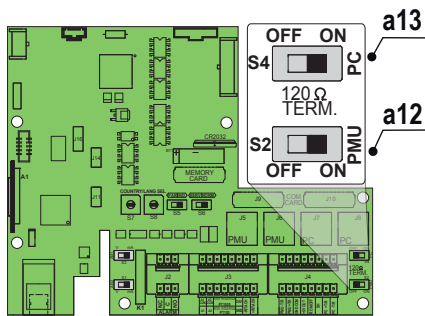
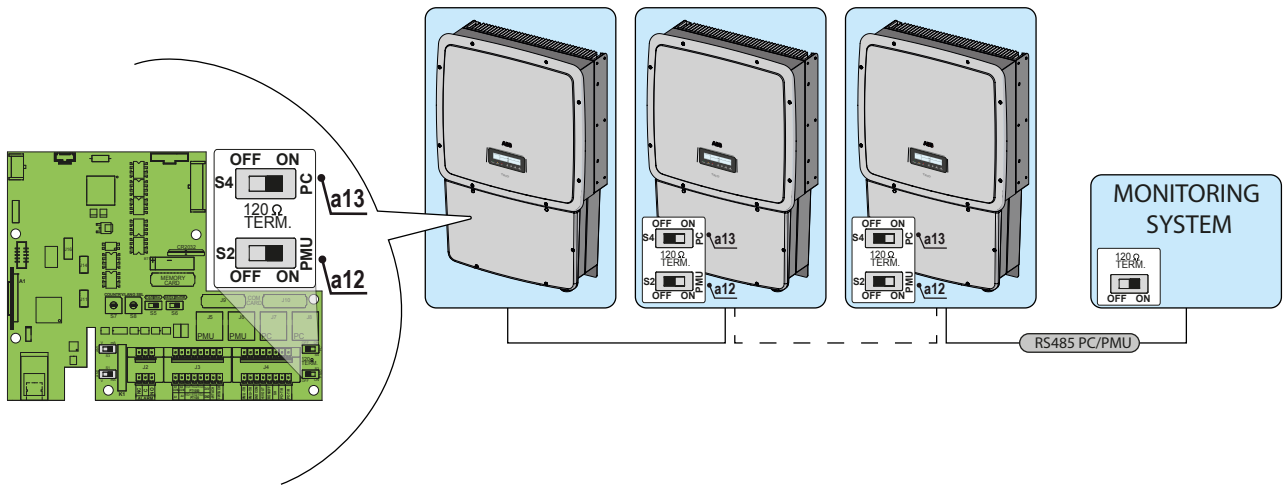

If a single inverter is connected to the monitoring system, activate the termination resistance of the communication line by switching switch a12 or a13 (to ON position).

Set a different RS485 address on each inverter of the chain. **No inverter should have “Auto” as its address.** An address can be chosen freely from out of 2 to 63.

The address on the inverter is set through the display and the push-button panel (see relevant chapter).



We recommend not exceeding a length of 1000m for the communication line. No more than 62 inverters can be connected to the same RS485 line.

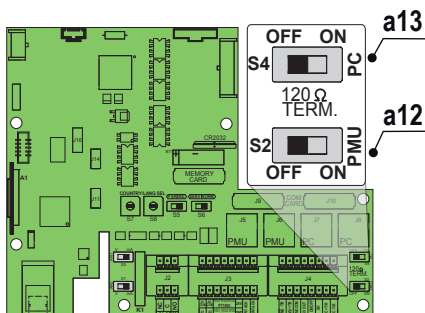

When using an RS-485 connection, if one or more inverters are added later to the system, you must remember to return to OFF position the switch of the termination resistance used (PC or PMU) of the inverter that was previously the last one of the system.

Each inverter is dispatched with two (2) as the predefined RS485 address and with switch for setting termination resistance a12 or a13 to OFF position.

Monitoring system via Aurora Communicator



The free Aurora Communicator software represents the basic instrument for monitoring the system.

For local monitoring, ABB recommends connecting its PVI-USB-RS485_232 adapter between the first unit of the daisy chain and the computer.

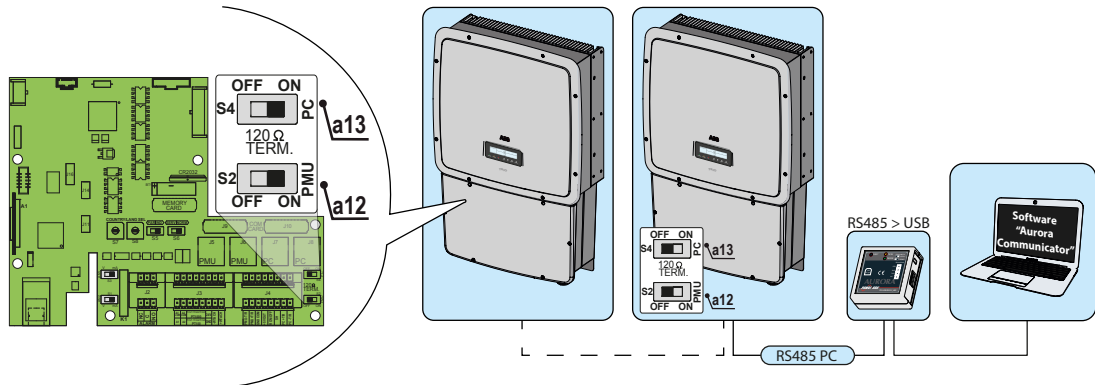

For the same purpose, it is also possible to use equivalent devices which are on general sale, but, taking into account the fact that they have never been specifically tested, ABB cannot guarantee the correct operation of the connection.

The converter, if combined with the use of configuration software, enables a change to be made to the inverter's internal parameters and other operations, including updating the firmware. In this case, if the RS485 line is very long, arrange to insert a 120Ohm resistance between the +T/R and -T/R terminals of the converter itself. Alternatively, the termination resistance of any monitoring device can be used (e.g.: PVI-AEC-EVO) which must necessarily be switched off.



Monitoring system via PVI-DESKTOP (Cabled)

The PVI-DESKTOP is an ideal device to monitor the performance of small residential or commercial systems (max. 6 inverters).

The device can be connected to a PC via a Bluetooth connection (BT version) or via a USB cable in order to download statistical information or to update the firmware.

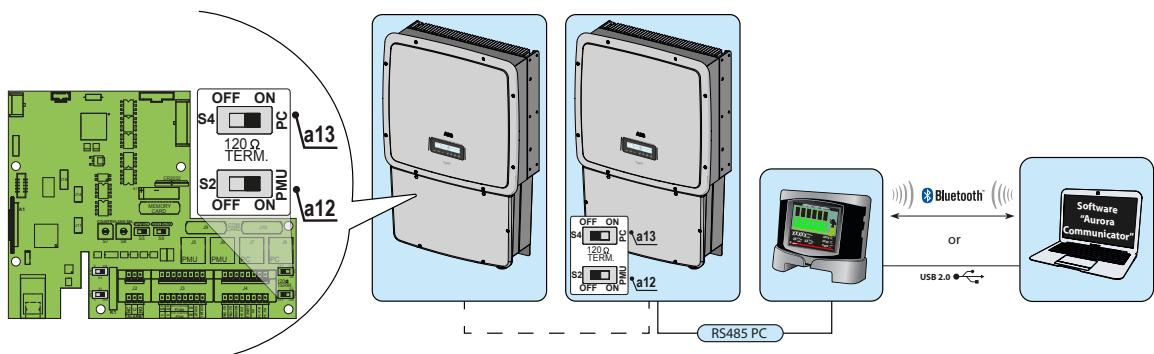

Monitoring system via PVI-DESKTOP and PVI-RADIOMODULE

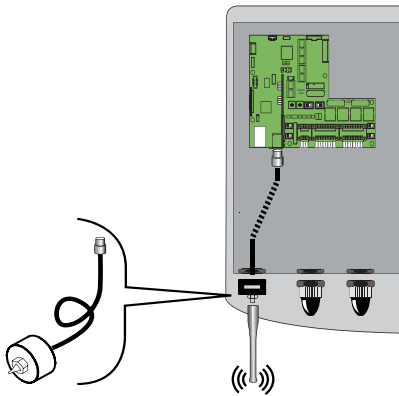

The PVI-RADIOMODULE board is an accessory which adds a wireless (radio) communication line to the RS485 line for the transmission of data to the monitoring device (PVI-DESKTOP).

The radiomodule board is installed on the communication board (09) vertically connecting the two connectors a03 (J11 / J14). In its turn, the radiomodule is connected to a cable which ends with an antenna which is installed outside the inverter in place of the service cable gland (10) of size M20.

The monitoring is done by using the **PVI-DESKTOP** device. The device can be connected to a PC via a Bluetooth connection (BT version) or via a USB cable in order to download statistical information or to update the firmware.

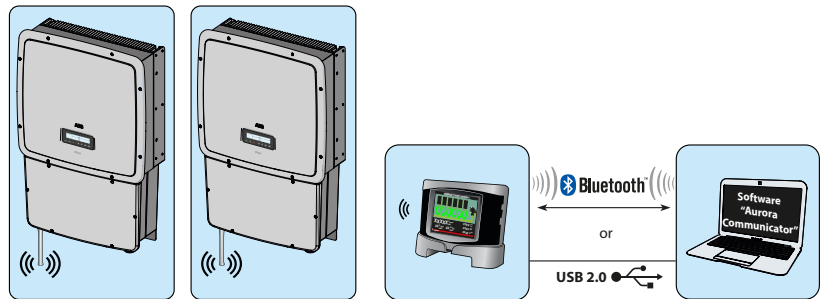

Monitoring system via PVI-AEC-EVO

The PVI-AEC-EVO is an ideal device for complete monitoring of ABB inverters. The device sends the data to the web portal where the data can be consulted remotely via online access. The main characteristics of the device are:

- 3 analogue inputs to connect the environmental sensors
- 6 digital inputs to acquire impulse signals from energy meters or status signal meters.
- Digital outputs to generate impulses that are proportionate to the energy produced by the system
- Availability of accessory expansion modules for data transmission through a GPRS data signal and for back-up should the grid voltage fail.

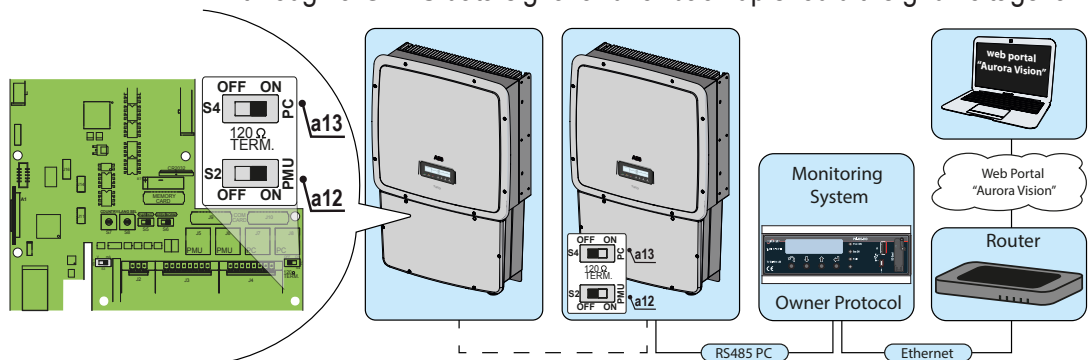

General conditions

One of the first rules for preventing damage to the equipment and to the operator is to have a thorough knowledge of the INSTRUMENTS. We therefore advise you to read this manual carefully. If you are not sure about anything or there is discrepancy in information, please ask for more detailed information.



Do not use the equipment if:

- *you do not have suitable qualifications to work on this equipment or similar products;*
- *you are unable to understand how it works;*
- *you are not sure what will happen when the buttons or switches are operated;*
- *you notice any operating anomalies;*
- *there are doubts or contradictions between your experience, the manual and/or other operators.*

ABB cannot be held responsible for damage to the equipment or the operator if it is the result of incompetence, insufficient qualifications or lack of training.

Display and keyboard



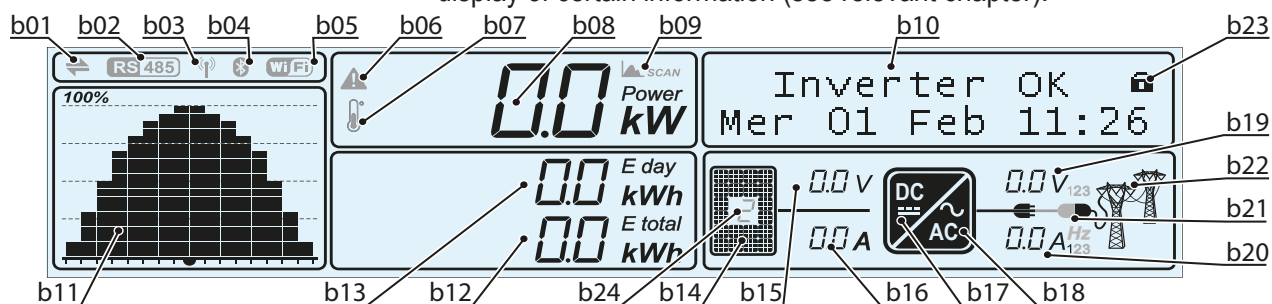

Display fields and symbols description

Using the display, operating parameters for the equipment are shown. signals, alarms, channels, voltages, etc.

The display, when in operation, behaves dynamically, allowing cyclical display of certain information (see relevant chapter).



Ref. Description

b01	Indicates transmission and reception of data through the RS485 line
b02	Indicates presence of the RS485 communication line
b03	Indicates presence of the radio communication line (radio module board installed)
b04	Indicates presence and readiness of the Bluetooth communication line (NOT available)
b05	Indicates presence and readiness of the WiFi communication line (NOT available)
b06	Reports an active power derating for out-of-range input voltage or power restrictions set by the grid manager or by the display
b07	Reports a power derating due to high internal temperature
b08	Instantaneous power placed on the grid
b09	MPPT SCAN function active
b10	Text lines to cyclically display the inverter parameters, error codes, and for menu navigation
b11	Graph of power introduced to grid (from 0 to 100%). Timescale can be set to 8/16/24 hours
b12	Displays the total energy from the inverter installation
b13	Shows the energy produced throughout the day
b14	Indicates that the PV generator voltage is greater than the inverter Vstart
b15	Input voltage (DC)
b16	Input current (DC)
b17	Indicates the DC/DC input circuit (Booster)
b18	Indicates the DC to AC conversion circuit
b19	Output voltage of phase highlighted
b20	Output current of phase highlighted. At the end of the currents display the grid frequency (Hz) is shown
b21	Connection to the grid:  Inverter not connected /  Inverter connected
b22	State of grid voltage: Icon absent: grid voltage not present Flashing icon: grid voltage present but outside parameters set by the standard grid Icon present: Grid voltage present and within parameters set by the standard grid
b23	Main menu scrolling mode:  CYCLIC : Cyclic display of the main parameters of the inverter.  LOCKED : Display locked on the screen to be constantly monitored.
b24	Indicates the channel which refers to the values of voltage and input current displayed. In the event of independent channels, parameters are displayed cyclically (channel 1 or 2)

Description of keyboard and LED Panel

Using the combination of keyboard keys, under the display, it is possible to set values or scroll through the data items to view them. LED indicators are located alongside the keyboard, indicating the operating state of the inverter.

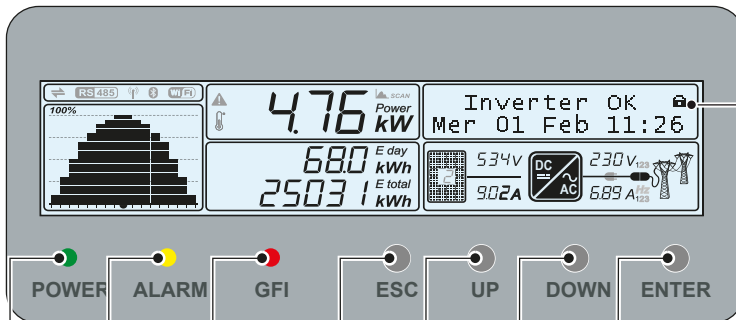

By pressing and holding the ENTER key, the cyclical display of the parameters can be:

- 🔒 Locked
- 🔄 Cyclical

Allows you to confirm the operation or enter the data set.

Allows you to read through the data in descending order on the display, or when inserting, correct the value set by reducing it

Allows you to read through the data in ascending order on the display, or when inserting, correct the value set by increasing it

Allows you to exit the current mode

The "GFI" (ground fault) LED indicates that the inverter has detected a ground fault in the DC side photovoltaic generator. When this fault is detected, the inverter immediately disconnects from the grid and displays the relevant error indication on the LCD display.

Indicates that the inverter has detected an anomaly. The type of problem will be shown in the display

Indicates that the inverter is functioning correctly.

When the unit is commissioned, while the grid is checked, this LED blinks. If a valid grid voltage is detected, the LED remains continuously lit, as long as there is sufficient sunlight to activate the unit. Otherwise, the LED will continue to blink until the sunlight is sufficient for activation. In this phase, the LCD display shows the message "Awaiting sun..."

The LEDs, in various multiple available combinations, can signal multiple conditions other than the original single condition; see the various descriptions explained in the manual.

The Keys, in various multiple available combinations, allow you to access actions other than the original single action; see the various descriptions explained in the manual.

General conditions

Before checking the operation of the equipment, it is necessary to have a thorough knowledge of the INSTRUMENTS chapter and the functions that have been enabled in the installation.

The equipment operates automatically without the aid of an operator; operating state is controlled through the instruments.

The interpretation or variation of some data is reserved exclusively for specialized and qualified staff.



The incoming voltage must not exceed the maximum values shown in the technical data in order to avoid damaging the equipment.

Consult the technical data for further details.

Even during operation, check that the environmental and logistic conditions are correct (see installation chapter).

Make sure that the said conditions have not changed over time and that the equipment is not exposed to adverse weather conditions and has not been isolated with foreign bodies.

Monitoring and data transmission

As a rule, the inverter operates automatically and does not require special checks. When there is not enough solar radiation to supply power for export to the grid (e.g. during the night), it disconnects automatically and goes into stand-by mode.

The operating cycle is automatically restored when there is sufficient solar radiation. At this point, the luminous LEDs on the LED panel will indicate this state.

User interface mode

The inverter is able to provide information about its operation through the following instruments:

- Warning lights (luminous LEDs)
- LCD display for displaying operating data
- Data transmission on the dedicated RS-485 serial line. Data may be collected by a PC (using signal converter PVI-USB-RS485_232) or a data logger with an RS-485 port (PVI-DESKTOP / PVI-AEC-EVO). Contact the ABB support service with any queries about device compatibility.

Types of data available

The inverter provides two types of data, which can be retrieved through the special interface software and/or the display.

Real-time operating data

Real-time operating data can be transmitted on request through the communication lines and are not recorded in the inverter.

Internally stored data

The inverter internally stores a set of data that are necessary for processing statistical data and an error log with time marking.

Measurement tolerance

The data supplied by the inverter may differ from measurements taken by certified measuring instruments (e.g. output meters, multimeters and grid analysers); since the inverter **is not a measuring instrument** it has wider tolerances for the measurements it makes.

The tolerances are generally:

- ±5% for real-time measurements with output power below 20%
- ±3% for real-time measurements with output power above 20%
- ±4% for all statistical data



Preliminary operations before commissioning

In order to commission the inverter it is necessary to carry out certain preliminary operation to ensure the inverter operates properly.

Grid standard setting of the country and language display

There are different grid parameters (dictated by the electricity distributor) according to the country in which the inverter is installed.



Setting the grid standard for the country of installation is a necessary operation before commissioning, and the installer must know the correct standard to be configured.

The inverter is configured using the rotary switches a05.

Before turning the rotary switches, make sure the inverter is switched off!

The table below shows which country grid standard and menu language are assigned to the various positions of the rotary switches a05

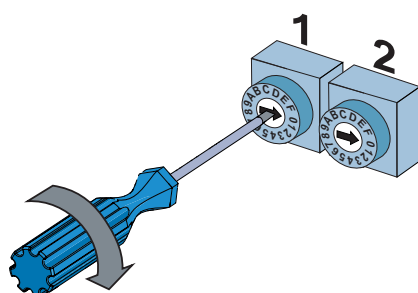
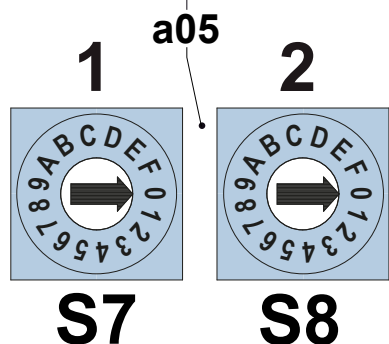
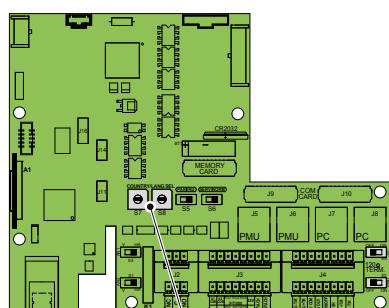

Table: country standard and language

Switch 1	Switch 2	Country Grid Standard	Display language	Displayed name
0	0	NON-ASSIGNED	ENGLISH	
0	1	GERMANY VDE 0126 @ 400V	GERMAN	VDE 0126
0	5	ENEL @ 400V	ITALIAN	ENEL
0	6	SPAIN RD1699 @ 400V	SPANISH	RD 1699
0	8	UK - G59 @ 400V	ENGLISH	UK G59
0	9	IRELAND @ 400V	ENGLISH	IRELAND
0	A	AUSTRALIA @ 400V	ENGLISH	AS 4777
0	B	ISRAEL @ 400V	ENGLISH	ISRAEL
0	C	GERMANY - BDEW @ 400V	GERMAN	BDEW
0	D	FRANCE @ 400V	FRENCH	FRANCE
0	E	NETHERLANDS @ 400V	DUTCH	NETHERL.
0	F	GREECE @ 400V	ENGLISH	GREECE
1	0	PORTUGAL @ 400V	ENGLISH	PORTUGAL
1	1	CORSICA @ 400V	FRENCH	CORSICA
1	2	HUNGARY @ 400V	ENGLISH	HUNGARY
1	4	KOREA @ 380V	ENGLISH	KOREA
1	5	TAIWAN @ 400V	ENGLISH	TAIWAN
1	6	CHECA Republic @ 400V	CZECH	CZECH
1	7	GERMANY-VDE AR-N-4105@400V	GERMAN	VDE 4105
1	8	CEI-021 @ 400V EXTERNAL Prot.	ITALIAN	CEI021 EX
1	B	SOUTH AFRICA @ 400V	ENGLISH	S.AFRICA
1	C	SPAIN RD 1565 @ 400V	SPANISH	RD 1565
1	D	BELG C10-11 100% @ 400V	FRENCH	C1011 100
1	E	BELG C10-11 110% @ 400V	FRENCH	C1011 110
1	F	BRAZIL @ 380V	ENGLISH	BRAZIL
2	0	TURKEY LV @400V	ENGLISH	TURKEY LV
2	1	ROMANIA @400V	ENGLISH	ROMANIA
2	2	SLOVENIA @400V	ENGLISH	SLOVENIA

Switch		Country Grid Standard	Display language	Displayed name
1	2			
2	3	TURKEY HV @400V	ENGLISH	TURKEY HV
2	4	CEI-016 @ 400V	ITALIAN	CEI 016
2	5	EN50438 generic @ 400V	ENGLISH	EN 50438



The list of grid standards given in the table was valid at the time of issue of the manual. It will be continually updated as new country standards with which the inverter is compatible are introduced

If the grid standard for the country of installation is not on the list, its presence can be checked by accessing the menu “INFORMATION>Country Selector>New Value” when the inverter is first switched on. Then turn the switches a05, and the grid standard for the position set will be displayed.



During this phase the inverter is on, so pay particular attention and always wear suitable protective equipment (e.g. Class 0 Category RC insulating gloves)

At the same time as the grid standard is set, **the language of the display menus** is also set.

Set Country

The predefined setting is **0 / 0** and means no grid standard is selected and the display language is English (in this case, the “Set Country” message will appear on the display).

Invalid Selection

If a position of switches not assigned on the display ²³ is selected, “Invalid Selection” appears.

Grid standard of the country and display language saving

The settings become fixed after 24 hours of operation of the inverter (it does not need to be connected to the grid, and only needs to be powered).

The time remaining before the settings become fixed can be seen in the dedicated menu, and a notice appears if the time has expired.

Once the settings are fixed, turning the rotary switches will produce no effect. In this condition, only the language can be changed through the dedicated menu.

At any time and for any reason, the ENGLISH language of the display menu can be set by simultaneously pressing the “ESC” and “ENTER” buttons for at least 3 seconds.

Checking the polarity of the strings (models S2F and S2X only)

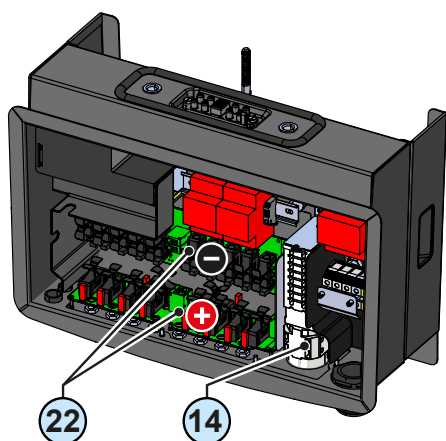

Inside the wiring box ⑫ installed in inverter models S2F and S2X there are two boards on which the string fuses are installed ⑬.

The board that is positioned horizontally at the bottom of the wiring box ⑫ contains the safety fuses on the positive poles of the strings connected in input, whereas the board that is installed vertically houses the negative string fuses.

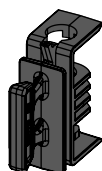

The string safety fuses are installed inside special positioners that allow easy installation/removal, as well as providing protection from involuntary contact while the inverter is being installed.

“Strings self-test” procedure

Automatic testing of the strings polarity is carried out using the following procedure.

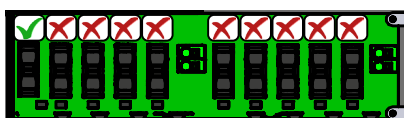

1. Before connecting the inverter input strings, remove all the fuses present on the board that is installed vertically (negative string fuses) except for the first one on the left, i.e. the one relating to input 1A.



Refer to the specific replacement procedure in the manual for information on the removal/installation procedure.

Once all the input strings foreseen have been connected, this operation enables the inverter to be switched on using input string 1A only, so as to check the polarity of all the other strings by reading the input voltages.

2. Connect all the strings foreseen by the project to the inverter

3. Turn the AC+DC Disconnect switch ⑭ to ON to supply the inverter with the both the grid voltage and the voltages from the PV generator strings.

- If the voltage from the only input string connected to the inverter is sufficient to switch the inverter on, but the display remains completely blank, then the polarity of the string connected is reversed. Open the disconnect switch and disconnect the string, change the polarity by reversing the connectors, connect the string to the inverter again and close the AC+DC disconnect switch ⑭.

- If the voltage from the only input string connected to the inverter is sufficient to switch the inverter on, the display will light up.

4. Enable the string polarity test using the advanced configuration software “Aurora Manager LITE” using the Tab Partner Device > Fuse Control Board > Global Settings > DC strings self-test and selecting “Test enabled”.

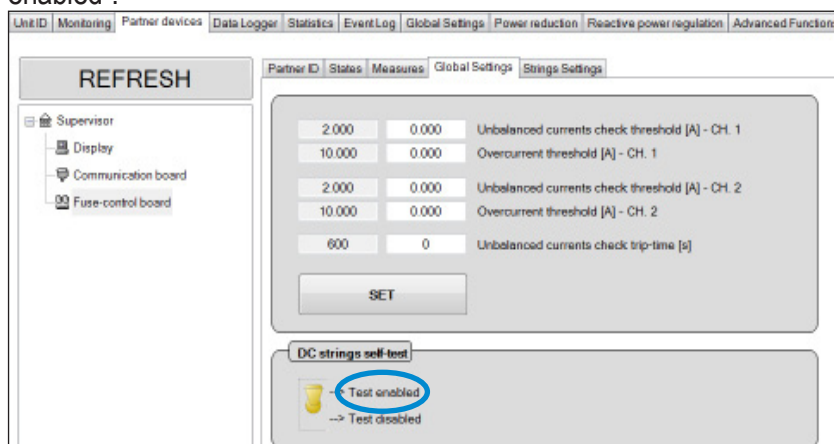

Please refer to the “Aurora Manager LITE” configuration software manual.

Once the Self-test function has been enabled the inverter will automatically start checking the polarity of the strings. Based on the results of the test two things might happen:

CASE 1 - Strings properly wired up

In this case the display will not show any inverted strings and the next operations in this procedure can go ahead.

CASE 2 - Strings improperly wired up

In this case the display will indicate the presence of one or more strings with reversed polarity and will indicate the input that is the source of the error. It is necessary to carry out the following operations before moving on to the next steps in the procedure:

- Turn the disconnect switch to OFF
- Correct the wiring on the strings identified as inverted
- Turn the disconnect switch to ON

At this point the error message should disappear and the next operations in this procedure can go ahead.

5. Switch the inverter off by turning the AC+DC disconnect switch ⑭ to OFF.

6. Disconnect all the inverter input strings

7. Install the missing fuses on the negative fuse board, using the positions provided

8. Connect up all the inverter input strings again

9. Fit the wiring box cover

Once this procedure has been completed the inverter can be commissioned.

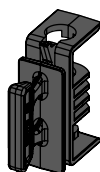

Check Strings!
STRING 4A ERROR

Installing the Wiring Box cover

When you have finished connecting and configuring the inverter, and before you start it up, you must install the Wiring Box cover.

IP65

During installation of the cover, perform the operations listed in order and use the specified torque for tightening the 6 screws (show in the technical data section) to maintain the inverter's IP level

Insert the 6 anchoring screws and give them a few turns.
Then tighten the screws, following the order and torque shown.

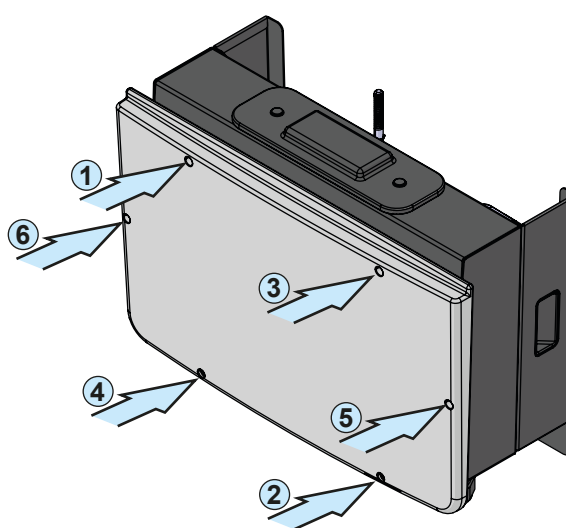

When you have finished installing the Wiring Box cover you may start up the inverter.



Commissioning

Do not place objects of any kind on the inverter during operation!



Do not touch the heatsink while the inverter is operating!
Some parts may be very hot and cause burns.

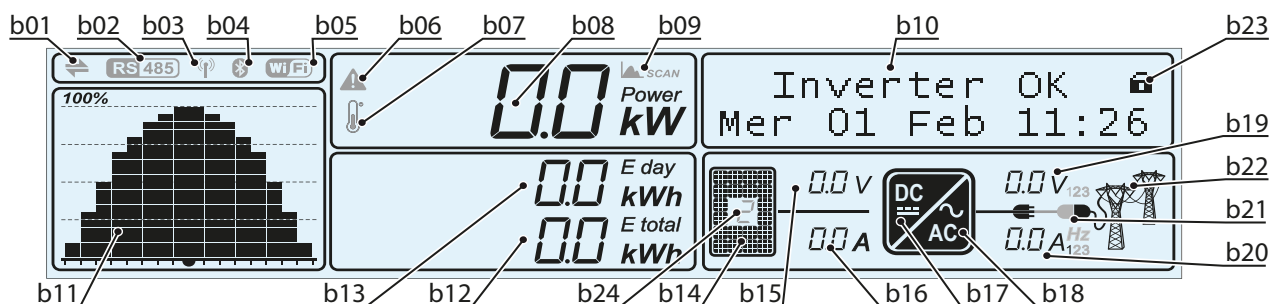

NOTE: Before proceeding with commissioning, make sure you have carried out all the checks and verifications indicated in the section on preliminary checks.

The inverter commissioning procedure is as follows:

- Put the AC+DC disconnect switch in ON position. If there are two separate external disconnect switches (one for DC and the other for AC), first close the AC disconnect switch and then the DC disconnect switch. There is no order of priority for opening the disconnect switches.

- When the inverter has power, the first check performed is the one relating to the input voltage:

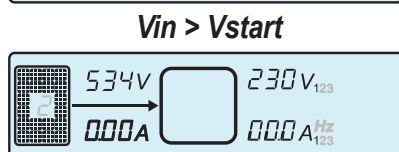
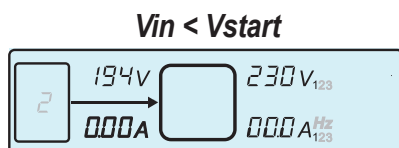

- If the DC input voltage is lower than the V_{start} voltage (voltage required to begin the inverter's grid connection) the **b14** icon remains off and the "Waiting for the sun" message is displayed **b10**.

- If the DC input voltage is higher than the V_{start} voltage the **b14** icon is displayed and the inverter goes to the next stage of the controls.

In both cases the voltage levels and input current are displayed in the **b15** and **b16** fields.

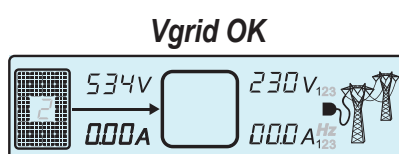

- The inverter performs a control of grid parameters. The **b22** icon, which represents the grid distribution, can have different statuses:

- Not present, if the mains voltage results as absent.

- flashing, if the mains voltage is present but outside the parameters dictated by the standard of the country of installation.

- Turns on, if the mains voltage is present and within the parameters dictated by the standard of the country of installation. In this condition, the inverter starts the sequence of grid connection.

This verification can take several minutes (from a minimum of 30 seconds up to several minutes), depending on grid conditions and settings relative to the standard of the country

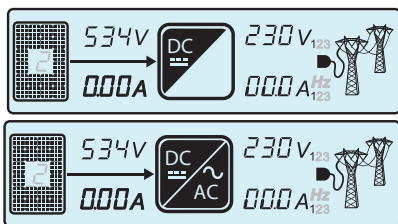

• At this point the **b17** icon will flash, this indicates the start-up of the DC-DC circuit (booster) part. This icon will remain permanently switched on when the DC-DC will be operating at steady state (the flashing of the icon usually lasts a few seconds).

Immediately after this, the **b18** icon, which indicates the AC-DC circuit (inverter) part, will also behave normally.

Inverter not connected to the grid

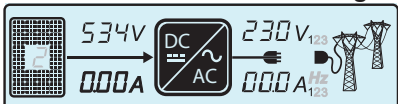

Inverter connected to the grid

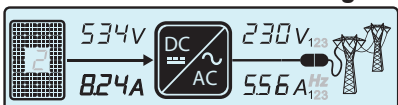

• Immediately after this the grid connection will start. During this phase the icons will be displayed in sequence on the **b21** board until the connection of the inverter. After the inverter is connected, the icons on the whole line **b21** will come on steady.

If the inverter disconnects from the grid, the icons of the left side (cable and plug) of the line **b21** will stay on.

• Once the connection sequence has been completed, the inverter starts to operate and indicates its correct operation by making a sound and by the green LED coming on steady on the LED panel. This means there is sufficient solar radiation to feed power into the grid.

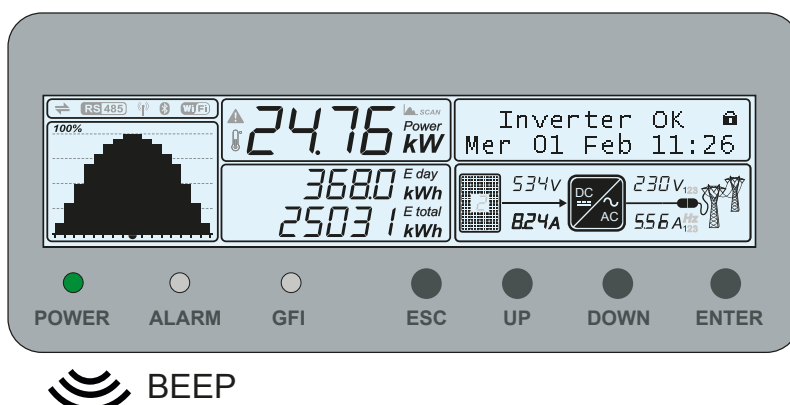

 BEEP

• If the checking of the grid does not give a positive result, the unit will repeat the procedure until all the parameters that allow connection to the grid (grid voltage and frequency, insulation resistance) are within the range. During this procedure, the green LED flashes.

Once the inverter has been started for the first time the wiring box must be configured by means of the dedicated Aurora Manager LITE software.

Display access and settings

After the commissioning of the inverter, it is possible/necessary to set the configuration of the inverter by accessing the “Account Settings” from the display. The following are the main adjustable parameters (see the section dedicated to the “**Menu descriptions**”)

- **Date and Time:** These must be set for the inverter to operate and store its log data correctly
- **Address RS485:** settings required in the case of system monitoring using the RS485 board
- **Vstart:** setting required in the case it is requested by the configuration during the system requirement phase (“Vstart” parameter)
- **MPPT scan:** allows you to carry out a search for the maximum power point with sensitivity and adjustable time intervals (“MPP” parameter).
- **Analogue inputs setting (where present):** allows you to set the parameters of the analogue sensors connected as the input (“Analogue Inputs”).
- **Input Strings (where present):** setting necessary to carry out checks on the status of the fuses and on the current imbalance of the strings present in the input (“Fuse control” parameters).
- **Reactive power input setting (where present):** setting necessary to manage the reactive power input into the grid in different ways (“Reactive Power parameter”)
- **Limitation active power setting (where present):** setting necessary to set a limit on active power output of the inverter (“Power reduction” parameter)



Dynamic behaviour of the display

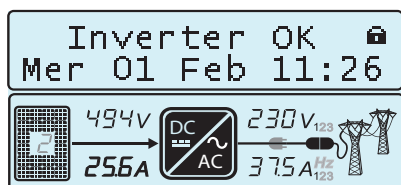

- If the MPPT scan function is enabled, icon **b9** will be shown on the display. See configuration in the MPPT settings menu section. This icon will flash during scanning.

- During operation, the following values are displayed in rotation:
 - Voltage and current (**b15** and **b16**) from the PV generator. According to the configuration or model of the inverter, the voltages and currents of one or both channels (or of the single strings) will be displayed. The input channel considered is indicated by the value entered on icon **b14**.
 - Voltage and current (**b19** and **b20**) on the various phases. According to the model of inverter, the voltages and currents of one (1) or three phases (1,2,3) will be displayed. The phase considered is shown on the right side of the voltage and current values.

At the end of the aforesaid display, the grid frequency will be indicated in field **b20** and the line voltage will be indicated in field **b19**.

At the same time, the main readings made by the inverter will be displayed in rotation on the graphic display **b10**.

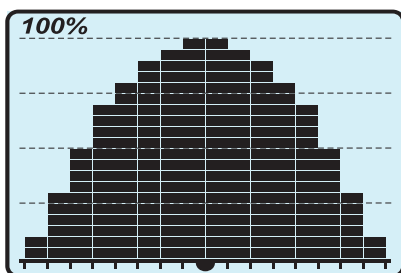

- Display of the power graph **b11**

The histogram includes 16 horizontal units and 20 vertical units.

The period of time is represented by the horizontal axis of the graph and can be set by the user to 8, 16 or 24 hours; therefore, each horizontal unit can represent 30, 60 or 120 minutes.

The vertical axis represents the maximum power derating and therefore 100% corresponds to this outgoing exported power value.

Finally, bear in mind that the power value expressed by each column of the graph represents the average value of the power during the period relating to the horizontal unit.



LED behaviour

- = LED On
- ⊗ = LED flashing
- ⊗ = LED Off
- ⊗ = Any one of the conditions described above

The following table shows all the possible activation combinations of LEDs on the LED panel according to the operating status of the inverter.

LED status	Operating state
green: ⊗ yellow: ⊗ red: ⊗	Firmware programming The inverter firmware is being programmed
green: ⊗ yellow: ⊗ red: ⊗	Night mode (inverter automatically switches off) The inverter is in night time switch-off mode (input voltage less than 70% of the set start-up voltage).
green: ⊗ yellow: ⊗ red: ⊗	Inverter initialisation This is a transitional state during verification of the operating conditions. During this stage the inverter checks that the conditions for connecting to the grid are met.
green: ● yellow: ⊗ red: ⊗	The inverter is connected and is feeding power into the grid Normal operation During this stage, the inverter automatically tracks and analyses the photovoltaic generator's maximum power point (MPP).
green: ⊗ yellow: ● red: ⊗	Disconnection from the grid Indicates no grid voltage. This condition does not allow the inverter to connect to the grid (the inverter display shows the message "Missing Grid").
green: ⊗ yellow: ● red: ⊗	Indication of Warning (W message codes) or Error (E message codes) states Indicates that the inverter control system has detected a warning (W) or error (E). The display shows a message indicating the type of problem found (see Alarm messages).
green: ⊗ yellow: ⊗ red: ⊗	<ul style="list-style-type: none"> • Ventilation anomaly Indicates an anomaly in the operation of the internal ventilation system that could limit output power at high ambient temperatures.
	<ul style="list-style-type: none"> • Failed association of internal inverter components (after replacement) Indicates that the installed wiring box (only in the event of a replacement) was already associated with another inverter and cannot be associated with the new inverter
	<ul style="list-style-type: none"> • Overvoltage surge arresters triggered (where fitted) Indicates that any class II overvoltage surge arresters installed on the AC or DC side have been triggered
	<ul style="list-style-type: none"> • String protection fuses triggered (where fitted) Indicates that one or more input string protection fuses that may be installed have been triggered
	<ul style="list-style-type: none"> • Autotest (for Italian grid standards only) The inverter is performing a self-test
green: ⊗ yellow: ⊗ red: ●	Anomaly in the insulation system of the photovoltaic generator Indicates that a leakage to ground from the FV generator has been detected, causing the inverter to disconnect from the grid.

Specifications on the behaviour of the LEDs

Next to each state of the inverter, indicated through the steady or intermittent lighting of the relevant LED, a message that identifies the operation it is carrying out or the detected fault/anomaly is also shown on the display (23), section b10, (see relevant chapter).

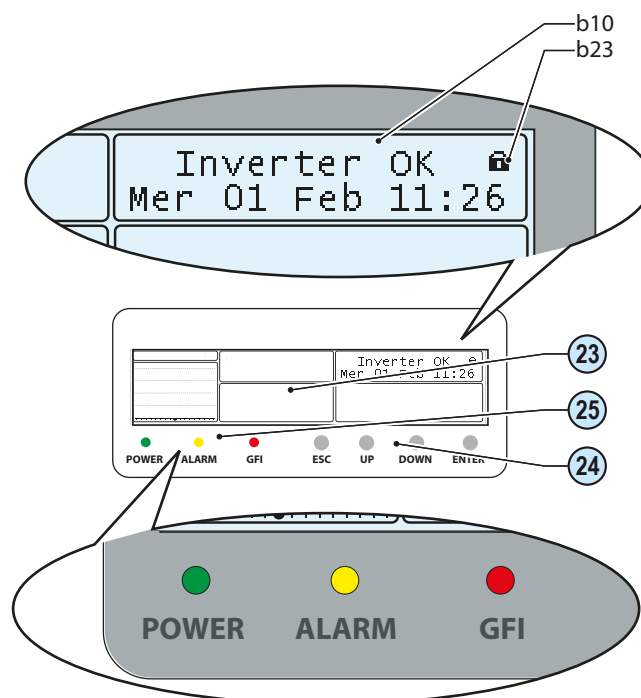

In the event of malfunctioning, it is extremely dangerous to try to eliminate the fault personally. The instructions given below must be strictly followed; if you do not have the experience and necessary qualification to work safely, please contact a specialized technician.



Insulation fault LED

What to do after an insulation fault warning

When the red LED comes on, first try to reset the warning through the multi-function button ESC on the LED panel (25).

If the inverter duly reconnects to the grid, the fault was due to temporary phenomena.

We advise having the system inspected by the installer or a specialized technician if this malfunctioning occurs frequently.

If the inverter does not reconnect to the grid, make it safe by isolating it (by means of the disconnect switches) on the both the DC side and the AC side, and then contact the installer or an authorized service centre to have the photovoltaic generator fault repaired.

Description of the menus

The display ②③ has a section b10 (graphic display) for moving through the menu using the buttons of the LED panel ②⑤.

Section b10 consists of 2 lines with 16 characters per line and can be used to:

- Cycle through the general information on:
 - Operating status and error/warning code indications
 - Inverter identification details
 - Active and reactive power management settings
 - Main parameters measured;
- Display statistical data;
- Display service messages for the operator;
- Change the inverter settings.

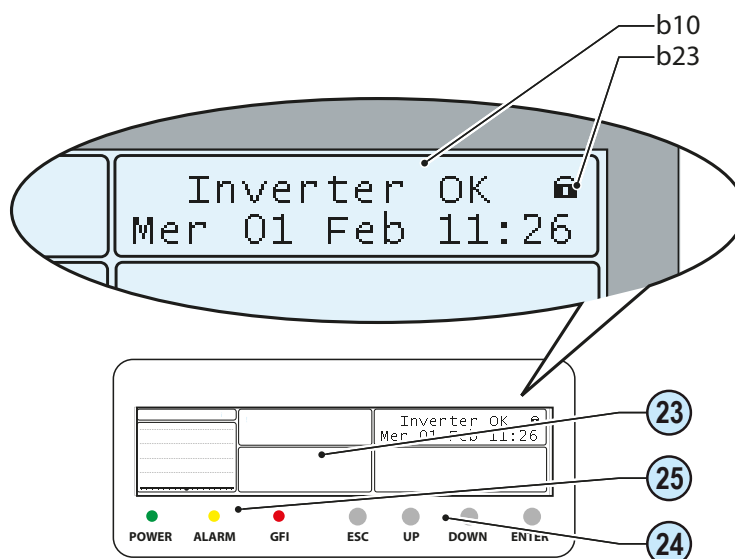

General information

While the inverter is operating, the display shows various items of information on the main parameters measured, the operating conditions and the inverter's operating status.

The display cycles through the information when the icon b23 shows two curved arrows ↻; if it shows a padlock 🔒 it means that the display of information is locked and the UP and DOWN buttons can be used to scroll through the screens of information instead. You can switch between the two display modes by pressing the ENTER button.

The sequence of screens displayed is shown below, with a description of the parameters monitored.

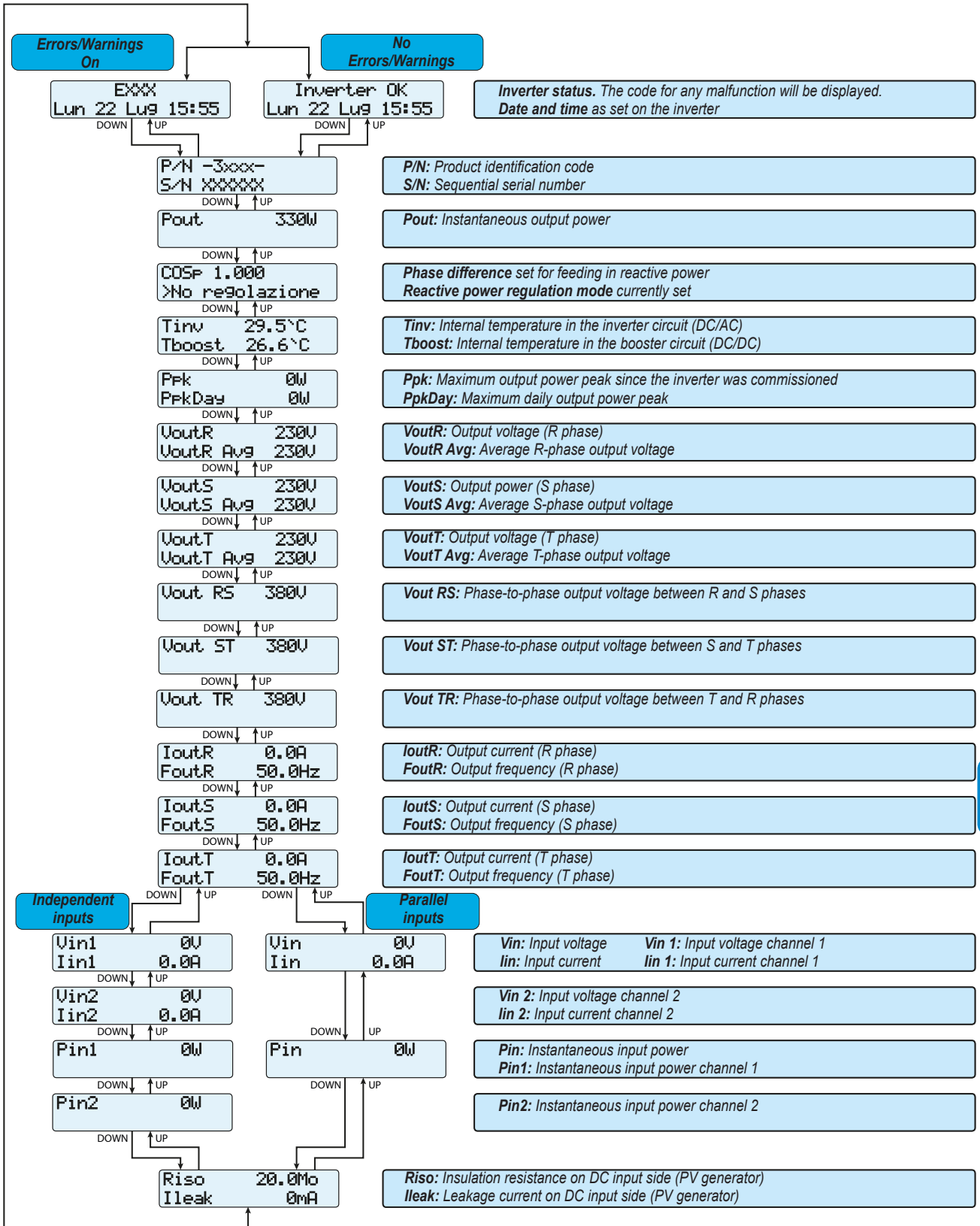

Statistics menu

Selecting STATISTICS from the three main sub-menus gives access to:

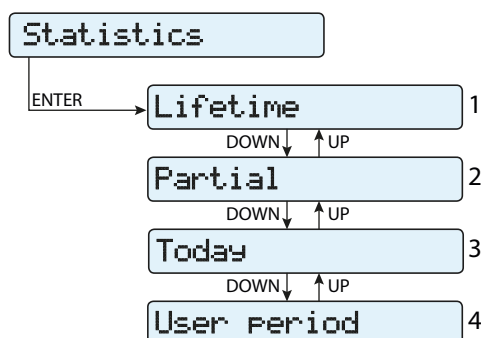

1. Lifetime

This section of the menu allows you to display the Total statistics:

- **Time:** Total operating time
- **E-tot:** Total energy produced
- **PPeak:** Peak power value

2. Partial

This section of the menu allows you to display the partial statistics:

- **Time:** Partial operating time
- **E-par:** Partial energy produced
- **PPeak:** Peak power value



To reset all the counters of this sub-menu, press the ENTER button for more than 3 seconds. At the end of this time, you will hear a sound repeated 3 times.

3. Today

This section of the menu allows you to display the daily statistics:

- **E-day:** Daily energy produced
- **Ppeak:** daily peak power value

8. User period

This section of the menu allows the statistics for a period selected by the user to be displayed:

Once the start and end dates for the period have been set, the following data are available:

- **E:** Energy produced during the selected period

Settings menu

When SETTINGS is selected from the three main sub-menus, the first screen for the password is displayed in the display.

The default password is "0000".

This can be changed using the display buttons, always following the same procedure:

- Use ENTER to scroll the digits (from left to right)
- Use ESC to return to the previous digit (from right to left)
- Press ESC several times to return to the previous menu
- Use DOWN to progressively scroll the numerical scale downwards (from 9 to 0)
- Use UP to progressively scroll the numerical scale upwards (from 0 to 9)

After entering the password, press ENTER to access the information gathered in this section:

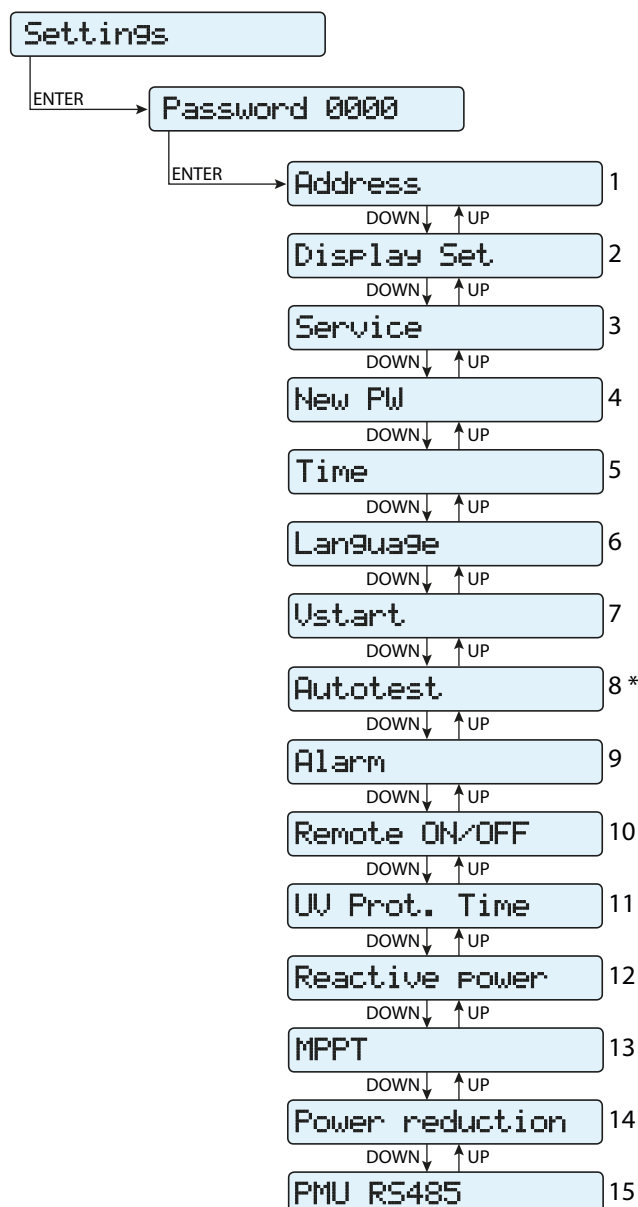

(*) Available for the Italian standard only. Refer to the section on this topic in the manual.



1. Address

This section of the menu allows you to set the address for the serial communication of single inverters connected to the RS485 line.

The addresses that can be assigned are 2 to 63. Use the UP and DOWN buttons to scroll the numerical scale.

At present, the 'AUTO' selection cannot be used

2. Display Set

This section of the menu allows you to set the timescale (8/16/24 hours) for the power graph shown on the display

3. Service

This section of the menu is reserved for installers. To access this, it is necessary to have a dedicated password which may be obtained from the website <https://registration.ABBsolarinverters.com>.

Before connecting to the site, make sure you have all the information required to calculate your password:

Inverter model

Serial Number and Week of Production

Update field

When you have a password you can set the parameters in the menu.

Due to the variation of the above mentioned parameters it is possible that the disconnection from the grid does not take place if the values exceed those mentioned in the standards of the country of installation. If these parameters exceed the standard values, install an interface protection, external to the inverter, which is compliant with the requirements of the country of installation.



The table below shows the parameters and the range of values that may be set:

Parameter	Parameter description	Setting range
Set U>>	Grid Over-voltage (OV) threshold (extended range)	Unom ... Unom x 1.3
Set U<<	Grid Under-voltage (UV) threshold (extended range)	10V ... Unom
Set F>>	Grid Over-Frequency (OF) threshold (extended range)	Fnom ... Fnom + 5Hz
Set F<<	Grid Under-Frequency (UF) threshold (extended range)	Fnom - 5Hz ... Fnom
Set U>	Grid Over-voltage (OV) threshold (strict range)	Unom ... Unom x 1.3
Set U> (10Min)	Grid Over-voltage (OV) threshold (measure of the average value of the mains voltage)	Unom ... Unom x 1.3
Set U<	Grid Under-voltage (UV) threshold (strict range)	10V ... Unom
Set F>	Grid Over-Frequency (OF) threshold (strict range)	Fnom ... Fnom + 5Hz
Set F<	Grid Under-Frequency (UF) threshold (strict range)	Fnom - 5Hz ... Fnom
Set Uconn>	Max voltage admissible during grid pre-connection phase	Unom ... Unom x 1.3
Set Uconn<	Min voltage admissible during grid pre-connection phase	10V ... Unom
Set Fconn>	Max frequency admissible during grid pre-connection phase	Fnom ... Fnom + 5Hz
Set Fconn<	Min frequency admissible during grid pre-connection phase	Fnom - 5Hz ... Fnom
Set Time U>>	Intervention time of Over Voltage (U>>) protection	0 ... 327670mS
Set Time U<<	Intervention time of Under Voltage (U<<) protection	0 ... 327670mS
Set Time F>>	Intervention time of Over Frequency (F>>) protection	0 ... 327670mS
Set Time F<<	Intervention time of Under Frequency (F<<) protection	0 ... 327670mS

Parameter	Parameter description	Setting range
Set Time U>	Intervention time of Over Voltage (U>) protection	0 ... 327670mS
Set Time U<	Intervention time of Under Voltage (U<) protection	0 ... 327670mS
Set Time F>	Intervention time of Over Frequency (F>) protection	0 ... 327670mS
Set Time F<	Intervention time of Under Frequency (F<) protection	0 ... 327670mS
Set time conn 1	Time lag, of grid parameters control, before connection	0 ... 65535mS
Set time conn 2	Time lag, of grid parameters control, before connection after grid fault	0 ... 65535mS
Disable U>>	U>> protection threshold disabling	Enable/Disable
Disable U<<	U<< protection threshold disabling	Enable/Disable
Disable F>>	F>> protection threshold disabling	Enable/Disable
Disable F<<	F<< protection threshold disabling	Enable/Disable
Disable U>	U> protection threshold disabling	Enable/Disable
Disable U> (10Min)	U> (10Min) protection threshold disabling	Enable/Disable
Disable U<	U< protection threshold disabling	Enable/Disable
Disable F>	F> protection threshold disabling	Enable/Disable
Disable F<	F< protection threshold disabling	Enable/Disable
U> (10Min) Der.	Enabling of power derating due to high average grid voltage value	Enable/Disable
Slow Ramp	Enabling gradual power immission into the grid after connection	Enable/Disable
OF Derating	Selection of power derating mode due to high value of grid frequency	0 Derating disable 1 Derating BDEW 2 Derating VDE-AR-N 3 Derating CEI
Reset Country S.	Unlocks the grid standard selection (resets the 24 hours available for changing the grid standard)	
Accept boards	Allow to associate a new inverter board (when replacing)	

4. New PW

This section of the menu allows you to change the password for accessing the settings menu (default 0000).



We ADVISE you to be very careful in memorizing the new password. If the Password is misplaced, it will not be possible to access the inverter, since there is no Reset function for security reasons.

5. Time

Allows you to set the current date and time (daylight saving time not included)

6. Language

Allows you to set the required menu language

7. Vstart Set

This section of the menu allows you to set the Vstart voltage (separately for both channels if they are configured in independent mode), to adapt it to the requirements of the system.



We advise changing the activation voltage only if really necessary and to set it to the correct value: the photovoltaic generator sizing instrument available on the Internet site of ABB indicates whether it is necessary to change the Vstart and the value to set.

8. Autotest

This section of the menu is available only for the Italian country standard. Refer to the section on this topic in the manual.

9. Alarm

This section of the menu allows you to set the activation status of a relay (available either as contact normally open – N.O. – or as contact normally closed – N.C.).

This contact can be used, for example, to: activate a siren or a visual alarm, control the disconnect device of an external transformer, or control an external device.

The relay can be set to switch in 4 different modes:

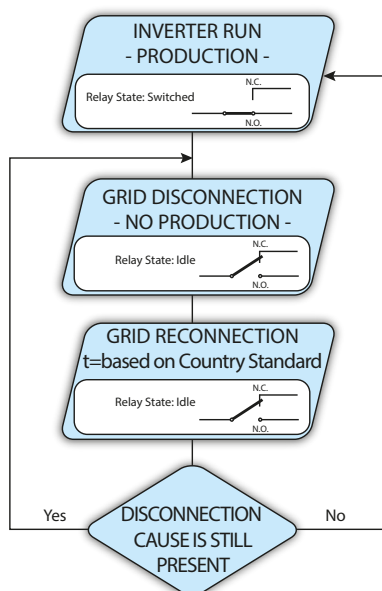

• Production (display text “Production”)

The relay is activated (state: switched) whenever the inverter connects to the grid; as soon as the inverter is disconnected from the network (for whatever reason that caused disconnection), the relay is in its resting position

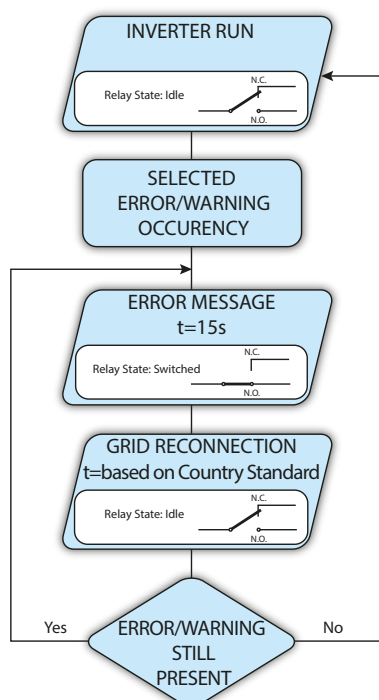

• Alarm with reset at the end of the alarm signalling process (display text “Alarm”):

The relay is activated (state: switched) whenever an error is present (code Exxx) on the inverter; this does not apply to warnings (Warning – code Wxxx). The alarm returns to its resting position when the alarm signal ends, i.e. before the inverter checks the grid parameters after the alarm state. This is because grid control state is not an alarm state but a state of normal operation.

Alarms for which the relay is activated

E001	E002	E003	E004	E005	E006
E007	E010	E011	E012	E013	E014
E015	E016	E017	E018	E019	E020
E021	E022	E023	E026	E029	E030
E031	E032	E033	E034	E046	E049
E050	E051	E053	E054	E055	E056
E057	E058	W003			

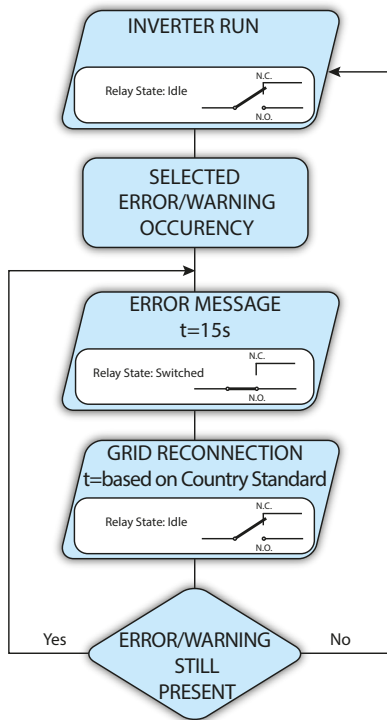

• **Configurable alarm with reset at the end of the alarm signalling process (display text “Alarm (Conf.)”)**

The relay is activated (state: switched) whenever an error is present (code Exxx) or a warning (code Wxxx) from those selected from the list in the dedicated submenu. The contact returns to its resting position when the alarm signal ends, i.e. before the inverter checks the grid after the alarm state. This is because grid control state is not an alarm state but a state of normal operation.

Selectable alarms for which the relay is activated

E001	E002	E003	E004	E005	E006
E007	E010	E011	E013	E014	E015
E017	E018	E019	E020	E021	E022
E023	E026	E027	E028	E029	E030
E031	E032	E033	E034	E046	E050
E051	E053	E054	E055	E056	E057
E058	W001	W002	W003	W008	W009
W011	W017	W018	W019	W021	W022
W023	W024	W025	W026	Ground fault	

For both configurable relay operating modes “Alarm” and “Alarm (Conf.)” the following considerations apply:

- If the alarm condition is persistent, the alarm contact cyclically switches from its resting state to its activated state.
- In the presence of W003 signalling (Grid Fail – Network parameters out of tolerance), the alarm contact switches to then reset itself at the end of the alarm signal. This means that during the absence of grid voltage (display message “Vac Absent”) the alarm contact remains in its resting position.
- In the presence of W002 signalling (UV Input – input voltage below the limit of operation), the alarm contact switches to then reset itself at the end of the alarm signal. This means that during the reduced input voltage (display message “Waiting sun”) the alarm contact remains in its resting position.

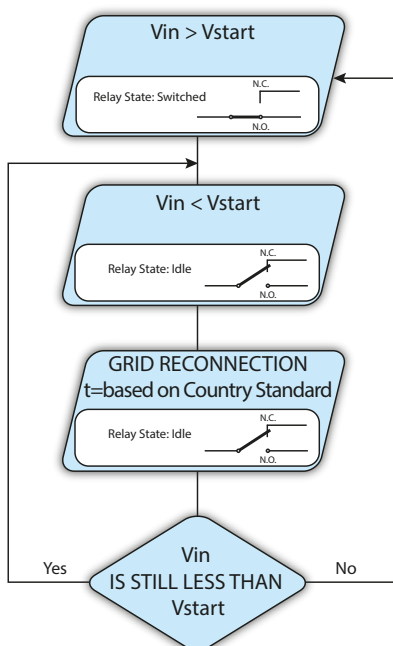

• **Crepuscular (display text “Crepuscular”)**

The relay is activated (state: switched) as soon as the inverter input voltage exceeds the activation voltage set.

The relay is in its rest position when the input voltage drops below 70% of the activation voltage set.

This mode is useful for disconnecting any output transformers that could have unnecessary consumption during the night.

10. Remote ON/OFF

This section of the menu allows you to enable/disable the connection/disconnection of the inverter to/from the grid through the relevant control signal (R ON/OFF).

- **Disable:** the connection/disconnection of the inverter to/from the grid is dictated by the input (voltage from the photovoltaic generator) and output (grid voltage) parameters of the inverter.
- **Enable:** the connection/disconnection of the inverter to/from the grid is dictated by the state of the R ON/OFF signal compared to the GND COM signal, as well as by the input (voltage from the photovoltaic generator) and output (grid voltage) parameters of the inverter.

11. UV Prot. Time

This section of the menu allows you to set the time for which the inverter stays connected to the grid after the input voltage has dropped below the Under Voltage limit (set at 70% of Vstart). ABB sets the time at 60 sec. The user can set it at any time from 1 to 3600 sec.

Example: with UV Prot. Time set at 60 seconds, if voltage V_{in} drops below 70% of Vstart at 9:00, the inverter stays connected to the grid (taking power from it) until 9:01.

12. Reactive power

This section of the menu may be used to manage the supply of reactive power into the grid. There are 5 possible types of management:

- **No regulation:** no regulation of reactive power. To enable this mode, select **Enable** and then **OK** (using the UP / DOWN arrows)
- **Cos-phi fixed:** Sets the power rating to a fixed value. To enable this mode, select **Enable** and then **OK** (using the UP / DOWN arrows) When enabled, **Set value** will appear on the display, allowing you to set the value of Cos-Phi (as either Over or Under excited, from 1.000 to 0.800)
- **Cos-phi = f(P):** Power rating as a function of the active power supplied by the inverter. To enable this mode, select **Enable** and then **OK** (using the UP / DOWN arrows). When it has been enabled, **Load std curve** will appear on the display, allowing you to set the following control curve:

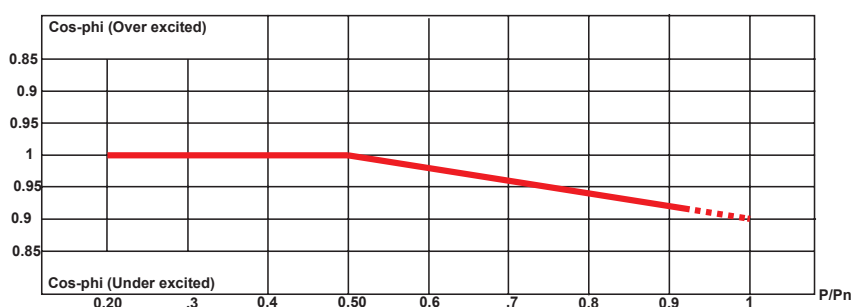

(*) The curve can be edited with the Aurora Manager LITE configuration software

- **Q = f(U):** reactive power as a function of the grid voltage measured by the inverter. To enable this mode, select **Enable** and then **OK** (using the

UP / DOWN arrows). When it has been enabled, **Load std curve** will appear on the display, allowing you to set the following control curve(*):

(*) The curve can be edited with the Aurora Manager LITE configuration software

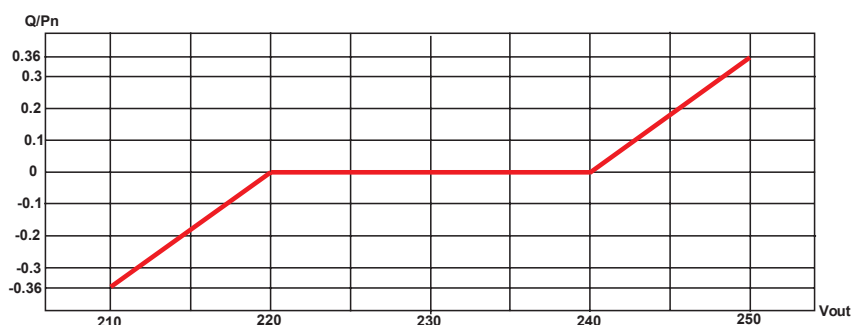

13. MPPT

This section of the menu allows you to set the parameters of the maximum power point tracking (MPPT) function. This function is useful when there are areas of shade on the PV generator, which may create several points of maximum power on the operating curve.

- **MPPT Amplitude:** by setting this parameter you can choose the amplitude of the DC perturbation introduced to establish the optimal operating point. There are 3 settings to choose from (LOW, MEDIUM, HIGH). The default setting is MEDIUM.

- **Multi-max scan:** by setting this parameter, you can enable/disable the scan, decide the frequency with which the scan is carried out and override it manually.

Enable/Disable: Enables/disables the scan for identifying the maximum power point of the system.

- **Scan Interval:** this allows you to set the time between scans. It should be borne in mind that the shorter the scan interval the greater the loss of production, due to the fact that energy is transferred to the grid during the scan but not at the maximum power point. Each scan takes roughly 2 seconds.

- **Manual Scan:** this allows you to start a manual scan of the photovoltaic generator (at a different time from the interval set in Scan Interval) in order to track the maximum power point.



14. Power reduction

This section of the menu allows you to adjust the limit to the active power that the inverter can feed into the grid by setting the percentage of nominal power at which the limit should be triggered.

Setting it to 100% resets the default maximum power, which in some installation country standards may be 110% of nominal power.

15. PMU RS485

This section of the menu allows you to configure the RS485 PMU serial port communication parameters:

- **Protocol:** used to select the PMU line communication protocol type between "Aurora" (proprietary communication protocol) and "ModBus RTU" (public communication protocol)

- **Baud Rate:** Communication line speed setting. This setting is only available for the "ModBus RTU" communication protocol.

Info Menu

Selecting INFO from the three main sub-menus gives access to:

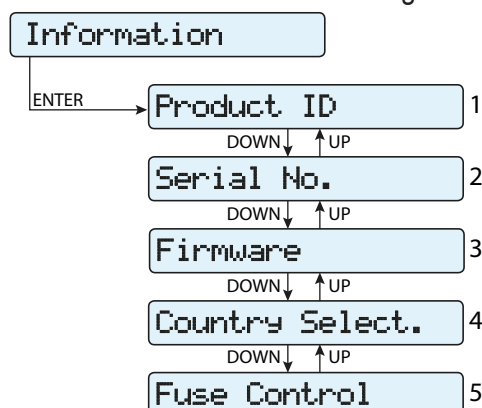

1. Product ID

Displays the model code

2. Serial No

Displays the serial number and week and year of manufacture of the equipment

3. Firmware

Displays the firmware version installed in the equipment and the “update version” field required to request a second-level password for the Service menu (along with the Serial Number and Week of Production).

4. Country Select.

Displays information on the grid standard set with the rotary switches.

- **Actual value:** Displays the grid standard set.
- **New value:** Allows you to select a new grid standard (by using the UP and DOWN buttons), which will only become effective when the equipment has been switched off and on again, or when the selection has been confirmed in the Set new value submenu described below.
The grid standard can only be changed if the time allowed for doing so (24 hours of operation) has not expired.
- **Set new value:** This allows you to confirm/set the new grid standard set in the “New value” section of the previous menu.
- **Residual time:** Displays the time remaining in which it is still possible to set a new grid standard. When the time expires, “Locked” will be displayed, which indicates it is not possible to change the grid standard again.

5. Fuse control (only -S2F / -S2X versions)

- **Strings:** Displays the voltage and the state of the strings present at the input of the equipment. A string can be in one of the following states: OK, OFF (damaged) and ABS (absent)
- **Currents:** Displays the current and the state of the strings present at the input of the equipment. A string current can be in one of the following states: OK, UNB (unbalanced current) and ABS (absent)



AUTOTEST procedure in accordance with standard CEI 0-21

The autotest run in accordance with grid standard **CEI-021** may be initiated from the display menu or by using an RS485/USB converter with the dedicated interface software (Aurora Communicator).

The conditions required to perform an Autotest are:

- The grid standard must be set to CEI-021.
- You must not intervene in any way while the test is underway
- You must check that the device has a stable network connection.

Running the tests from the display menu

In the Autotest section of the SETTINGS menu, select the type of test the device is to run from the following:

OV Test – parameters:

U>>R, U>>S, U>>T; U>R, U>S, U>T;

U> (10Min)R, U> (10Min)S, U> (10Min)T

Disconnection from the distribution grid due to “Over-voltage”

UV Test – parameters:

U<<R, U<<S, U<<T: U<R, U<S, U<T

Disconnection from the distribution grid due to “Under-voltage”

OF Test – parameters:

F>> and F>

Disconnection from the distribution grid due to “Over-frequency”

UF Test – parameters:

F<< and F<

Disconnection from the distribution grid due to “Under-frequency”

Go to the SETTINGS > Autotest menu

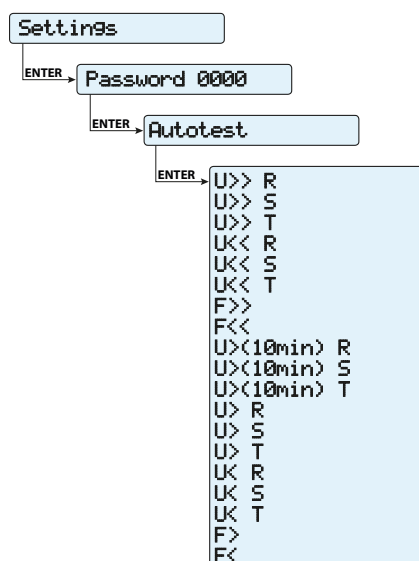

Various signs may be displayed alongside the parameters on which the autotest can be performed. These have the following meanings:

N/A - Test cannot be performed because the relevant parameter is not active

Idle - Test enabled but not yet performed

OK - Test enabled and performed successfully

If one of the protections is disabled (from the Service menu), N/A (not applicable) will appear next to the name of the test.

While one of the tests is being performed, the set limits will be gradually increased/reduced (depending on the type of test) until the threshold at which the inverter is disconnected from the grid is reached. The procedures for running the Autotest comply with the legislation in force.

```
Test in corso
*****
```

The display shows the message “Performing Test” when the test has started.

At the end of the test, when the inverter has disconnected from the grid, the results and values of the test performed will appear on the display. You can move from one screen to another using the UP/DOWN arrow keys.

Details of the data available in each screen are provided below:

Screen 1 of 3

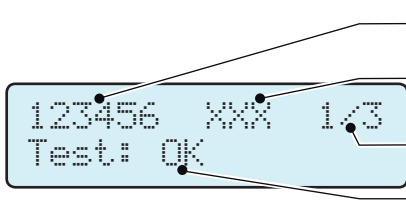

```
123456 XXX 1/3
Test: OK
```

Inverter serial number
Parameter tested (e.g. U>>)
Screen number
Test result

Screen 2 of 3

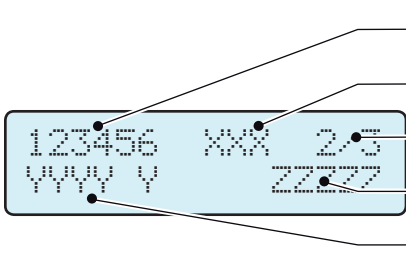

```
123456 XXX 2/3
YYYY Y ZZZZ7
```

Inverter serial number
Parameter tested (e.g. U>>)
Screen number
Value of the grid parameter detected when the protection was tripped
Measured protection tripping time

Screen 3 of 3

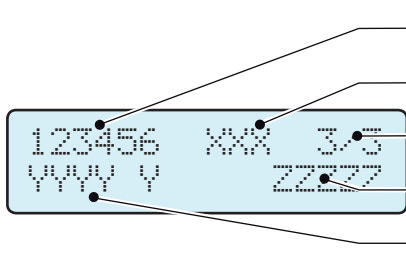

```
123456 XXX 3/3
YYYY Y ZZZZ7
```

Inverter serial number
Parameter tested (e.g. U>>)
Screen number
Protection tripping value
Set protection tripping time

The test results should be considered valid on the basis of the following tolerances, as reported in the applicable legislation:

- $\leq 5\%$ for voltage thresholds
- ± 20 mHz for frequency thresholds
- $\leq 3\% \pm 20$ ms for tripping times

Press ESC to go back to the Autotest menu, from where you may select the next test to be performed

Turning off the inverter



Some parts may be very hot and could cause burns.



Some inverter parts may be subject to voltages that could be hazardous for the operator. Before performing any work on the inverter, follow the procedure for turning off the inverter.

Standard Wiring Box Version

- Disconnect any power supplies that may be connected to the configurable relay.

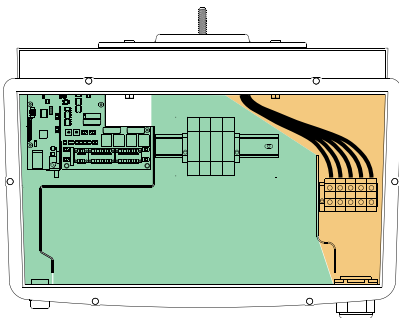

- Switch off the DC switch on the outside of the inverter. **Under this condition the wiring box has hazardous voltages, identified by the colour ORANGE (400V AC). Green areas may be freely accessed.**

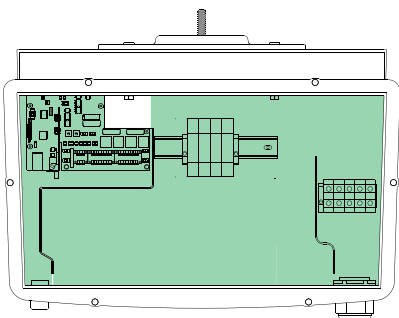

- Disconnect grid voltage (by switching off the protective device upstream of the inverter). **Under these conditions the wiring box does not have any hazardous voltages and all areas may be freely accessed.**



Wait enough time for it to discharge before performing any operations on the inverter

Wiring Box Versions S2, S2F and S2X

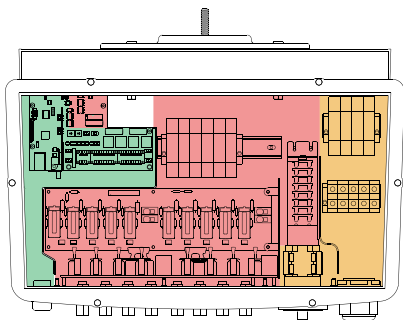

- Put the AC+DC switch¹⁴ in the OFF (open) position.

Under this condition the wiring box has hazardous voltages, identified by the colours RED (up to 1000 V DC) and ORANGE (400V AC). Green areas may be freely accessed.

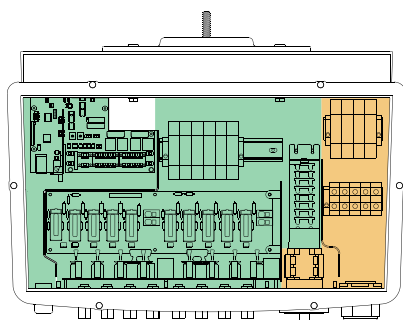

- Disconnect any power supplies that may be connected to the configurable relay.

- Disconnect input strings.

The OFF switch may be used to disconnect the strings without any danger of creating an arc discharge.

Under this condition the wiring box has hazardous voltages, identified by the colour ORANGE (400V AC). Green areas may be freely accessed.

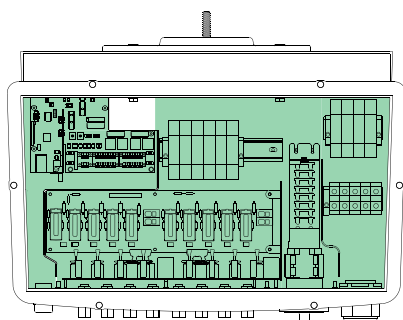

- Disconnect grid voltage (by switching off the protective device upstream of the inverter) .

Under these conditions the wiring box does not have any hazardous voltages and all areas may be freely accessed.



Wait enough time for it to discharge before performing any operations on the inverter

General conditions

Checking and maintenance operations must be carried out by specialized staff assigned to carry out this work.



Maintenance operations must be performed with the apparatus disconnected from the grid (power switch open) and the photovoltaic panels obscured or isolated, unless otherwise indicated.



*For cleaning, DO NOT use rags made of filamentary material or corrosive products that may corrode parts of the equipment or generate electrostatic charges.
Avoid temporary repairs. All repairs should be carried out using only genuine spare parts.
The maintenance technician is under an obligation to promptly report any anomalies.*

DO NOT allow the equipment to be used if problems of any kind are found, and restore the normal conditions correctly or otherwise make sure that this is done.



Always use the personal protective equipment provided by the employer and comply with the safety conditions of the Accident prevention chapter.

Routine maintenance

Scheduled maintenance operations are not mandatory, but are recommended to preserve the efficiency of the PV plant.



We recommend that maintenance operations be carried out by qualified personnel or by the personnel of ABB (as set forth in a maintenance contract).

The periodicity of the maintenance operations may vary in accordance with local environmental conditions and the installation

Table: routine maintenance

Annual visual inspection	<ul style="list-style-type: none"> • Check that the inverter is operating correctly, and that no fault alarms are present • Ensure all the labels and safety symbols are visible • Test the integrity of the cables, connectors, and plugs external to the inverter • Check that the environmental conditions have not changed drastically since the installation of the system
Annual operations	<ul style="list-style-type: none"> • Check that cable glands and connection block screws are tight • Check that the wiring box cover is properly closed • If no monitoring system is present, check the history log of alarms and errors using the instructions given in the manual in order to look for recent malfunction warnings
Annual cleaning	<ul style="list-style-type: none"> • Clean the equipment; in particular the bottom grille of the wiring box and the heat sink

Troubleshooting

Follow the table shown in the following paragraph in order to understand and resolve warning (Wxxx) and error (Exxx) messages displayed by the inverter



The operations carried out on the inverter in order to identify and resolve malfunctions may be carried out only by the organization that carried out the installation or by qualified personnel

Alarm Messages

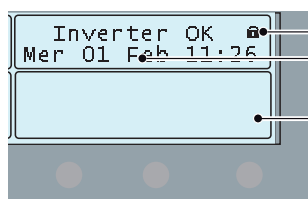

b23

b10











23

25











The equipment is able to indicate errors/warnings on the display only if the input voltage is higher than the V_{dcmin} voltage (POWER LED flashing or on; see operation chapter).

The messages and their codes are indicated on the highlighted part b10 of the display 23.

The following table gives the complete list of errors/warnings relating to string inverters. Some error/warning codes may not be used depending on the inverter model installed.

- Code on display - Error message - Signal	Name of Alarm and Cause	Solution
<ul style="list-style-type: none"> - No code - Ground F -  Red LED 	<p>Ground fault of photovoltaic generator: The alarm is generated when a leakage current to ground is detected in the DC section of the system.</p>	<ul style="list-style-type: none"> • Measure the insulation resistance using a megohmmeter positioned in the photovoltaic field (positive terminal short-circuited at the negative pole) compared to ground. The measurement is strongly influenced by the environmental conditions, so must be taken under the same conditions in which the error occurred. - If the value measured is lower than 1 megaohm, a check must be carried out by a technician/installer on the photovoltaic generator to identify and eliminate the problem. - If the value measured is higher than 1 megaohm and the error signal persists, contact customer assistance.
<ul style="list-style-type: none"> - No code - NEW COMPONENT REFUSED! -  Yellow LED lamp. 	<p>Lack of linkage of the new component: The components inside the inverter (e.g. display, fuse board, communication and control board, etc.) are not inter-linked. This occurs following the replacement of one of the components inside the inverter.</p>	<ul style="list-style-type: none"> • Link the components inside the inverter by accessing the "Settings > Service > Accept boards" (refer to the procedure given in this manual). - If the signal persists also following the linking of the components, contact customer assistance.
<ul style="list-style-type: none"> - No code - SET COUNTRY or NO NATION -  No LED 	<p>SET COUNTRY or NO NATION: Indicates that in the installation phase the grid standard was not set on the inverter.</p>	<ul style="list-style-type: none"> • Set the grid standard of the country of installation following the instructions given in this manual for the inverter. - If the signal persists also following setting the grid standard, contact customer assistance.
<ul style="list-style-type: none"> - No code - Vac absent -  Yellow LED 	<p>Vac absent: The inverter displays the "Vac absent" message when it does not record output voltage (AC side).</p>	<ul style="list-style-type: none"> • Check the grid voltage on the inverter's AC terminal block. - Should it be absent, check any protection work on the line and the presence of grid voltage on the supply point.
<ul style="list-style-type: none"> - No code - Mem. broken -  Yellow LED 	<p>Memory broken: The inverter displays the "Memory broken" message when it records a communication problem with the memory board on which the inverter saves the daily value of energy produced.</p>	<ul style="list-style-type: none"> • Remove the memory board and check the welding of all the connector's terminals. Subsequently reinsert the memory board and check that it is correctly inserted into the dedicated slot - If the signal persists also following the above checks, contact customer assistance.
<ul style="list-style-type: none"> - No code - Awaiting sun -  Green LED lamp. 	<p>Awaiting sun: The inverter displays the "awaiting sun" message when, following a W001 and/or W002 notice, the voltage from the photovoltaic generator is less than the activation voltage (Vstart).</p>	<ul style="list-style-type: none"> • Check the input voltage on the inverter. - If it does not exceed Vstart, check for the presence of sufficient irradiation and the correct composition of the system. - If it exceeds Vstart, contact customer assistance
<ul style="list-style-type: none"> - W001 - Sun Low -  Yellow LED 	<p>Insufficient irradiation (Low input voltage on switching on the inverter): Incorrect configuration of the PV generator or an "on the limit" configuration for the inverter's minimum input voltage.</p>	<ul style="list-style-type: none"> • Check the input voltage on the inverter. - If it does not exceed Vstart, check for the presence of sufficient irradiation and the correct composition of the system. - If it exceeds Vstart, contact customer assistance
<ul style="list-style-type: none"> - W002 - Input UV -  Yellow LED 	<p>Insufficient irradiation (Low input voltage on switching off): Incorrect configuration of the photovoltaic generator or an "on the limit" configuration for the inverter's minimum input voltage.</p>	<ul style="list-style-type: none"> • Check the input voltage on the inverter. - If it does not exceed Vstart, check for the presence of sufficient irradiation and the correct composition of the system. - If it exceeds Vstart, contact customer assistance
<ul style="list-style-type: none"> - W003 - Grid Fail -  Yellow LED 	<p>Parameters of grid voltage outside range: This error signal occurs when during the inverter's normal operation the grid parameters exceed the limits set by the operator: - Grid voltage absent (after the signal the inverter goes to "Vac Absent") - Unstable grid voltage (down or up) Unstable grid frequency</p>	<ul style="list-style-type: none"> • Check the grid voltage on the inverter. - Should it be absent, check for absence of grid voltage on the supply point. - If, on the other hand, the voltage tends to rise (when the inverter is connected) there is high line or grid impedance. • Check the grid voltage also on the supply. - If it is high, it means that there is high grid impedance. In this case, ask the operator to adjust the grid voltage. If the operator authorises a change to the inverter's parameters, agree the new limits with customer assistance - If the voltage at the point of supply is much lower than that measured on the inverter, it is necessary to adjust the line (inverter-contactor). - If the voltage and the grid frequency come back within the limits (also when the inverter is connected to the grid) contact customer assistance
<ul style="list-style-type: none"> - W009 - Empty Table -  Yellow LED 	<p>Characterisation board for the wind generator not compiled (only WIND models)</p>	<p>(only WIND models)</p>



- Code on display - Error message - Signal	Name of Alarm and Cause	Solution
- W010 * - Fan broken! -  Yellow LED lamp. *not visualised on display	Fan broken: This error occurs when there is a malfunction in the fan/fans inside the inverter.	<ul style="list-style-type: none"> • Error inside the inverter and cannot be checked externally. - If the alarm repeats persistently, contact customer assistance.
- W011 - Bulk UV -  Yellow LED	Bulk Under-voltage: The alarm (which is a warning and not an error) is generated when the voltage at the heads of the bulk capacitors does not reach the threshold for the operation of the inverter (internal unchangeable threshold).	<ul style="list-style-type: none"> • Raise the value of the activation voltage (Vstart) so as to have sufficient power from the PV generator at the time of the inverter's grid connection. • Check the input voltage on the inverter. - If it does not exceed Vstart, check for the presence of sufficient irradiation and the correct composition of the system. - If it exceeds Vstart, contact customer assistance
- W012 * - Batt. Flat -  Yellow LED *not visualised on display	Battery flat: The inverter displays the "Battery flat" message when it records a voltage for the buffer battery which is too low.	<ul style="list-style-type: none"> • Check that the date/time are set correctly and, if they are not, set them. Subsequently arrange to completely switch off the inverter (on both AC and DC) and wait a few minutes. Finally, restart the inverter and check whether the date/time are now correctly set or whether they have reset to 01/01/2000. In this case replace the battery with the inverter completely switched off (section AC and DC side) being careful to maintain the polarity
- W013 * - Clock broken -  Yellow LED *not visualised on display	Clock broken: The alarm occurs when there is a difference of over 1 minute in the time displayed compared to the internal time of the microprocessors and indicates a malfunction of the clock circuit.	<ul style="list-style-type: none"> • Error inside the inverter and cannot be checked externally. - If the alarm repeats persistently, contact customer assistance.
- W017* - String Err. -  Yellow LED lamp. * (only for models with monitored string fuses)	Error recorded in measuring string currents: Damaged string protection fuse(s)	<ul style="list-style-type: none"> • Check with a multimeter the state of the fuses (positioned on the fuse boards). - If one or more fuses is open, arrange to replace them and check that the input current on the string(s) does not exceed the rating of the fuses (should parallel strings have been made outside the inverter). - If there are no damaged string fuses and the inverter continues to show the alarm message check whether the settings to be made through the Aurora Manager software are correct (presence or absence of one or more input strings).
- W018 * - SPD DC Err -  Yellow LED lamp. * (only for models with monitored SPD)	Intervention of overvoltage surge arresters on DC side: Damaged overvoltage surge arresters positioned on DC side	<ul style="list-style-type: none"> • Observe the inspection window on each surge arrester (DC side). If it is red, the surge arrester is damaged and the cartridge must be replaced. - If the alarm status persists, even if all the surge arresters have a green inspection window, contact customer assistance.
- W019 * - SPD AC Err -  Yellow LED lamp. * (only for models with monitored SPD)	Intervention of overvoltage surge arresters on AC side: Damaged overvoltage surge arresters positioned on AC side	<ul style="list-style-type: none"> • Observe the inspection window on each surge arrester (AC side). If it is red, the surge arrester is damaged and the cartridge must be replaced. - If the alarm status persists, even if all the surge arresters have a green inspection window, contact customer assistance.
- W022 * - Reactive power mode changed -  No LED *not visualised on display	Variation in means of managing reactive power: Variation in the means of managing reactive power; this change can be made through the display or advanced configuration software.	The variation in the means of managing reactive power is done directly by the customer/installer and is not an error. The information is only saved on the historic record of the events memorised by the inverter
- W023 * - date/time changed -  No LED *not visualised on display	Variation in the inverter's date and time: Variation of the inverter's date and time; this change can be made through the display or advanced configuration software.	The variation in the inverter's date and time is done directly by the customer/installer and is not an error. The information is only saved on the historic record of the events memorised by the inverter
- W024 * - Energy data reset -  No LED *not visualised on display	Zeroing of the statistical energy data memorised in the EEPROM: Reset of the energy data saved in the inverter; this operation can be handled through the display or advanced configuration software.	The zeroing of the partial energy values memorised by the inverter is done directly by the customer/installer and is not an error. The information is only saved on the historic record of the events memorised by the inverter <ul style="list-style-type: none"> • The notice may also occur on substitution of the Memory Card where the statistical production data is saved



- Code on display - Error message - Signal	Name of Alarm and Cause	Solution
- E001 - Input OC - ● Yellow LED	Input over-current (photovoltaic generator): The alarm occurs when the inverter's input current exceeds the inverter's threshold for maximum input current.	<ul style="list-style-type: none"> • Check whether the composition of the PV generator enables input current which exceeds the maximum threshold allowed by the inverter and that the configuration of the inputs (independent or in parallel) is carried out correctly. - If both checks are positive, contact customer assistance.
- E002 - Input OV - ● Yellow LED	Input over-voltage (photovoltaic generator): The alarm is generated when the input voltage (from the PV generator) exceeds the inverter's threshold of maximum input voltage. The alarm occurs before reaching the absolute threshold over which the inverter is damaged. When the inverter's input voltage exceeds the Over Voltage threshold, the inverter will not start up due to the generation of the alarm.	<ul style="list-style-type: none"> • It is necessary to measure the input voltage inside the inverter with a voltmeter. - If it is higher than the maximum voltage of the operating range, the alarm is genuine and it is necessary to check the configuration of the PV generator. If the voltage has also exceeded the maximum input threshold the inverter could be damaged. - If it is lower than the maximum voltage of the operating range, the alarm is caused by an internal malfunction and it is necessary to contact customer assistance.
- E003 - No Parameters - ● Yellow LED	DSP initialisation error: The main microcontroller cannot initialise correctly the two DSPs (booster stage and inverter stage). The error is caused by communication problems on the inverter's internal bus.	<ul style="list-style-type: none"> - Error inside the inverter and cannot be checked externally. - If the problem (once the inverter has been switched off and back on) persists, contact customer assistance.
- E004 - Bulk OV - ● Yellow LED	"Bulk" over-voltage (DC-DC circuit): Error inside the inverter. The alarm is raised when the voltage at the heads of the bulk capacitors exceeds the Over Voltage threshold (internal unchangeable threshold).	<ul style="list-style-type: none"> • The alarm may be triggered by causes external to the inverter: - An excessive input voltage can be recorded as a condition for bulk over voltage. In this case it is advisable to check the inverter's input voltage and should this value be close to the input OV threshold, review the configuration of the photovoltaic generator. - Excessive grid voltage could cause the bulk voltage to rise in uncontrolled fashion with a consequent protection intervention and hence generation of the alarm. In these cases the alarm is transitory and the inverter automatically restarts - The alarm may be triggered by causes inside the inverter and in this case it is necessary to contact customer assistance.
- E005 - Comm.Error - ● Yellow LED	Communication error inside the inverter: The alarm occurs when there are communication problems between the control devices inside the inverter.	<ul style="list-style-type: none"> • Error inside the inverter and cannot be checked externally. - If the problem (once the inverter has been switched off and back on) persists, contact customer assistance.
- E006 - Output OC - ● Yellow LED	Output over current: The alarm occurs when the inverter's output current exceeds the inverter's threshold for maximum output current.	<ul style="list-style-type: none"> • Error inside the inverter and cannot be checked externally. - If the problem (once the inverter has been switched off and back on) persists, contact customer assistance.
- E007 - IGBT Sat - ● Yellow LED	Saturation recorded on the IGBT components: The alarm occurs when one of the inverter's active devices is in a saturated state.	Once the error occurs, the inverter tries to return to normal operation. <ul style="list-style-type: none"> - Should the error occur sporadically, it may be caused by a brusque transition of the grid voltage or of the input voltage, but is not due to a malfunction by the inverter. - If the error is connected to an internal breakdown, it will continue to appear and so it is necessary to contact customer assistance.
- E009 - Internal error - ● Yellow LED	Error inside the inverter: Error inside the inverter	<ul style="list-style-type: none"> • Error inside the inverter and cannot be checked externally. - If the problem (once the inverter has been switched off and back on) persists, contact customer assistance.
- E010 - Bulk Low - ● Yellow LED	Low "Bulk" voltage (DC-DC circuit): <ul style="list-style-type: none"> • The alarm may be triggered by causes external to the inverter: a reduced input voltage on the inverter (just above the activation voltage) but which is not accompanied by a sufficient availability of power from the photovoltaic generator (typical condition of the stages with limited irradiation) 	<ul style="list-style-type: none"> - If the error signal occurs sporadically, it may be due to causes external to the inverter (limited irradiation and so limited power availability from the PV generator). - If the problem occurs systematically also in conditions of high irradiation and with input voltage which is significantly higher than the activation voltage, contact customer assistance.
- E011 - Ramp Fail - ● Yellow LED	Long wait for "Booster" regime to start: Error internal to inverter relating to start up time for DC-DC circuit regime (Booster)	<ul style="list-style-type: none"> • Error inside the inverter and cannot be checked externally. - If the problem (once the inverter has been switched off and back on) persists, contact customer assistance.
- E012 - DcDc Fail - ● Yellow LED	Error in the "Booster" circuit (DC-DC side) recorded by the "Inverter" circuit (DC-AC side): Error internal to inverter relating to operation of the DC-DC circuit regime (Booster)	<ul style="list-style-type: none"> • Error inside the inverter and cannot be checked externally. - If the problem (once the inverter has been switched off and back on) persists, contact customer assistance.



- Code on display - Error message - Signal	Name of Alarm and Cause	Solution
- E013 - Wrong Mode - Yellow LED	Incorrect configuration of inputs (set in parallel rather than independent): The alarm is generated solely when the inverter is configured with parallel inputs. In this particular configuration the inverter checks the input voltage of each of the two channels and if the two voltages differ by more than 20Vdc, the alarm is raised .	<ul style="list-style-type: none"> • Check that the setting of the "IN MODE" switch is specifically set to "PAR" and that the bridges between the two input channels have been included. - If the configuration of the inverter is correct, check that the input strings have the usual number of standard panels of the usual brand and with the same inclination/orientation. - If both the configuration of the inverter and the characteristics of the PV generator conform with the specifications, contact customer assistance.
- E014 - Over Temp. - Yellow LED	Excessive temperature inside the inverter: External temperature over 60°C. This parameter also depends on the power which the inverter must supply since the measurement of temperatures is done internally and is influenced by the heat dissipated by the components of the inverter itself	<ul style="list-style-type: none"> • Check that the inverter is not exposed to direct sunlight. Wait for the temperatures to which the inverter is exposed to return to the operating range and for the inverter to cool down. - If the problem (once the ambient temperature has returned to the range) persists, contact customer assistance. Remember to wait the time needed to allow the inverter to cool down
- E015 - Bulk Cap Fail - Yellow LED	Breakdown recorded on the "Bulk" capacitor: Error inside the inverter relating to a problem in the bulk capacitors.	<ul style="list-style-type: none"> • Error inside the inverter and cannot be checked externally. - If the problem (once the inverter has been switched off and back on) persists, contact customer assistance.
- E016 - Inverter Fail - Yellow LED	Error in the "Inverter" circuit (DC-AC side) recorded by the "Booster" circuit (DC-DC side): The alarm is generated when a problem is recorded in the inverter circuit (DC/AC)	<ul style="list-style-type: none"> • Error inside the inverter and cannot be checked externally. - If the problem (once the inverter has been switched off and back on) persists, contact customer assistance.
- E017 - Start Timeout - Yellow LED	Long wait for "Inverter" regime to start up: Error internal to inverter relating to start-up time for the DC-AC circuit regime (Inverter) <ul style="list-style-type: none"> • The alarm may be triggered by causes external to the inverter: a reduced input voltage on the inverter (just above the activation voltage) but which is not accompanied by a sufficient availability of power from the photovoltaic generator (typical condition of the stages with limited irradiation) 	<ul style="list-style-type: none"> - If the error signal occurs sporadically, it may be due to causes external to the inverter (limited irradiation and so limited power availability from the PV generator). - If the problem occurs systematically also in conditions of high irradiation and with input voltage which is significantly higher than the activation voltage, contact customer assistance.
- E018 - Ground Fault - Red LED	High leakage current measured on the DC side (photovoltaic generator): The alarm is generated when, during normal operation of the inverter, a leakage current to ground is detected in the DC section of the system. It is also possible that the inverter generates the alarm E018 message also due to AC leakage currents connected to the capacitive nature of the photovoltaic generator compared to ground.	<ul style="list-style-type: none"> • Measure the insulation resistance using a megohmmeter positioned between the photovoltaic field (positive terminal short-circuited at the negative pole) compared to ground. The measurement is strongly influenced by the environmental conditions, so must be made under the same conditions in which the error occurred. - If the value measured is lower than 1 megaohm, a check must be carried out by a technician/installer on the photovoltaic generator to identify and eliminate the problem. - If the value measured is higher than 1 megaohm and the error signal persists, contact customer assistance.
- E019 - leak sense.fail - Yellow LED	Failure of test on sensor to measure the leakage current (DC side): Before connecting to the grid the inverter runs a self-test regarding the sensor for the leakage current. The test is carried out by "forcing", in the sensor of the leakage current, a current with a known value: the microprocessor compares the value read with the known value. The error is generated if the comparison between the read value and the known value during the test does not fall within the allowed tolerance.	<ul style="list-style-type: none"> • Error inside the inverter and cannot be checked externally. By its nature, the alarm only occurs prior to connection to the grid - If the problem (once the inverter has been switched off and back on) persists, contact customer assistance.
- E020 - Self Test Error 1 - Yellow LED	Failure of the test on the relay of the "Booster" (DC-DC circuit): Before connecting to the grid the inverter carries out internal tests. One of these tests concerns the correct operation of the booster relay. The test is carried out by "forcing" the switching of the relay and checking its operation. The error is generated if a problem is found in actioning the relay.	<ul style="list-style-type: none"> • Error inside the inverter and cannot be checked externally. By its nature, the alarm only occurs prior to connection to the grid - If the problem (once the inverter has been switched off and back on) persists, contact customer assistance.



- Code on display - Error message - Signal	Name of Alarm and Cause	Solution
<ul style="list-style-type: none"> - E021 - Self Test Error 2 - ● Yellow LED 	<p>Failure of the test on the inverter's relay (DC-AC circuit): Before connecting to the grid the inverter carries out internal tests. One of these tests concerns the correct operation of the inverter relay. The test is carried out by "forcing" the switching of the relay and checking its operation. The error is generated if a problem is found in actioning the relay.</p>	<ul style="list-style-type: none"> • Error inside the inverter and cannot be checked externally. By its nature, the alarm only occurs prior to connection to the grid - If the problem (once the inverter has been switched off and back on) persists, contact customer assistance.
<ul style="list-style-type: none"> - E022 - Self Test Error 4 - ● Yellow LED 	<p>Timeout of the tests undertaken on the relays inside the inverter: Execution time for the self-test carried out on the relay of the DC_AC (inverter) circuit too high. It may indicate a problem connected to the aforementioned relays</p>	<ul style="list-style-type: none"> • Error inside the inverter and cannot be checked externally. - If the problem (once the inverter has been switched off and back on) persists, contact customer assistance.
<ul style="list-style-type: none"> - E023 - DC in error - ● Yellow LED 	<p>Feeding of continuous current to grid outside of range: The error is generated if the continuous component of the current supplied to the grid exceeds the threshold of 0.5% of the normal operating current. In any case the inverter is not blocked due to the E023 error, but tries to reconnect to the grid. The sporadic repetition of the error is a sign of serious grid distortions or sharp irradiation changes, while systematic repetition of the error signal will indicate a breakdown on the inverter</p>	<p>Once the error occurs, the inverter tries to return to normal operation.</p> <ul style="list-style-type: none"> - Should the error occur sporadically, it may be caused by a brusque transition of the grid voltage or of the input voltage, but is not due to a malfunction by the inverter. - If the error is connected to an internal breakdown, it will continue to appear and so it is necessary to contact customer assistance.
<ul style="list-style-type: none"> - E024 - Internal error - ● Yellow LED 	<p>Error inside the inverter: Error inside the inverter</p>	<ul style="list-style-type: none"> • Error inside the inverter and cannot be checked externally. - If the problem (once the inverter has been switched off and back on) persists, contact customer assistance.
<ul style="list-style-type: none"> - E025* - Riso Low - ● Yellow LED <p>*not visualised on display</p>	<p>Low value of insulation resistance: Before connecting to the grid the inverter measures the insulation resistance of the PV generator compared to ground. Should the measurement of the insulation resistance be below 1Mohm, the inverter does not connect to the grid and shows the "Riso Low" error. The causes may be:</p> <ul style="list-style-type: none"> - PV panel(s) damaged; - Junction box(es) of the panels not correctly sealed, so as to permit infiltration by water and/or humidity; - Problems in connections between panels (not perfectly fit); - Poor quality of cable joints; - Presence in the DC section of unsuitable or damaged overvoltage surge arresters outside the inverter (reduced ignition voltage compared to the characteristics of the strings of the PV generator); - Presence of humidity inside any junction box 	<ul style="list-style-type: none"> • Measure the insulation resistance using a megohmmeter positioned in the photovoltaic field (positive terminal short-circuited at the negative pole) compared to ground. The measurement is strongly influenced by the environmental conditions, so must be made under the same conditions in which the error occurred. - If the value measured is lower than 1 megaohm, a check must be carried out by a technician/installer on the photovoltaic generator to identify and eliminate the problem. - If the value measured is higher than 1 megaohm and the error signal persists, contact customer assistance.
<ul style="list-style-type: none"> - E026 - Vref Error - ● Yellow LED 	<p>Internal reference voltage outside of range: Wrong measurement of reference voltage inside inverter</p>	<ul style="list-style-type: none"> • Error inside the inverter and cannot be checked externally. - If the problem (once the inverter has been switched off and back on) persists, contact customer assistance.
<ul style="list-style-type: none"> - E027 - Error Meas V - ● Yellow LED 	<p>Grid voltage outside of range: Error in the internal measurement of grid voltage (set by law) in order to have a redundant measurement (2 measurements on the same parameter made by two different circuits)</p>	<ul style="list-style-type: none"> • Error inside the inverter and cannot be checked externally. - If the problem (once the inverter has been switched off and back on) persists, contact customer assistance.
<ul style="list-style-type: none"> - E028 - Error Meas F - ● Yellow LED 	<p>Grid frequency outside of range: Error in the internal measurement of grid frequency (set by law) in order to have a redundant measurement (2 measurements on the same parameter made by two different circuits)</p>	<ul style="list-style-type: none"> • Error inside the inverter and cannot be checked externally. - If the problem (once the inverter has been switched off and back on) persists, contact customer assistance.
<ul style="list-style-type: none"> - E029 - Mid Bulk OV - ● Yellow LED 	<p>Internal over voltage on the measurement of the "Mid bulk": Error internal to the inverter (only triphase models)</p>	<ul style="list-style-type: none"> • Error inside the inverter and cannot be checked externally. - If the problem (once the inverter has been switched off and back on) persists, contact customer assistance.



- Code on display - Error message - Signal	Name of Alarm and Cause	Solution
- E030 - Error Meas Ieak - ● Yellow LED	High leakage current (DC side): Error in the internal measurement (made when the inverter is grid connected) of the leakage current of the DC side (PV generator) compared to ground (set by law) in order to have a redundant measurement (2 measurements on the same parameter made by two different circuits)	<ul style="list-style-type: none"> • Error inside the inverter and cannot be checked externally. - If the problem (once the inverter has been switched off and back on) persists, contact customer assistance.
- E031 - Error Read V - ● Yellow LED	Output relay damaged: Measurement of internal voltage on heads of the output relay outside of range. There is too great a difference in voltage between the input and output of the grid connection relay.	<ul style="list-style-type: none"> • Error inside the inverter and cannot be checked externally. - If the problem (once the inverter has been switched off and back on) persists, contact customer assistance.
- E032 - Error Read I - ● Yellow LED	Imbalanced output currents: Measurement of the unbalance in the output voltage (made across the three phases) outside of range (only in triphase models)	<ul style="list-style-type: none"> • Error inside the inverter and cannot be checked externally. - If the problem (once the inverter has been switched off and back on) persists, contact customer assistance.
- E033 - UTH - ● Yellow LED	Low ambient temperature: Temperature outside the inverter below -25°C	<ul style="list-style-type: none"> • Wait for the temperatures to which the inverter is exposed to return to the operating range. - If the problem persists, contact customer assistance. Remember to wait the time needed to allow the inverter to warm up
- E034 - Interlock fail - ● Yellow LED	"IGBT" circuitry not ready: Error inside the inverter	<ul style="list-style-type: none"> • Error inside the inverter and cannot be checked externally. - If the problem (once the inverter has been switched off and back on) persists, contact customer assistance.
- E035* - Remote Off - ● Yellow LED *not visualised on display	Inverter awaiting "remote ON" command: The inverter has been switched off remotely (remote OFF) and remains awaiting the signal which will switch it back on (Remote ON)	<ul style="list-style-type: none"> • Switch back on the inverter remotely. If the unit does not switch back on, disable the remote off/on function and switch the equipment off completely and subsequently switch it back on. - If the problem (once the Remote ON/OFF function from the display has been reactivated) persists, contact customer assistance.
- E036 - Vout Avg error - ● Yellow LED	Average of the measurements of grid voltage outside of range: The average value of the grid voltage (sampled every 10 minutes) does not fall within the permitted ranges. The grid voltage in the point connected to the inverter is too high. This may be caused by too high a grid impedance. In the final stage of the timeout, the inverter limits the power to check whether the grid voltage has stabilised into regular parameters. If this does not happen, the inverter disconnects from the grid	<ul style="list-style-type: none"> • Check the grid voltage in the connection point to the inverter. - If the grid voltage differs from the range due to the conditions of the distribution grid, ask the operator to adjust the grid voltage. - If the operator authorises a change to the inverter's parameters, agree the new limits with customer assistance
 - E037 - Riso Low - ● Red LED	Low value of the insulation resistance (only with the "Amorphous" mode activated): This error can occur only should the "Amorphous" mode be on. This function is on only in inverters equipped with a grounding kit and serves to monitor the voltage at the heads of the grounding resistance. The error occurs when the voltage at the heads of the resistance connected between ground and the pole of the photovoltaic generator exceeds 30V for more than 30 minutes or 120V for more than one second.	<ul style="list-style-type: none"> • Check for the presence and correct contact between the two terminals of the grounding resistance installed inside the inverter • Measure the insulation resistance using a megohmmeter positioned in the photovoltaic field (positive terminal short-circuited at the negative pole) compared to ground. The measurement is strongly influenced by the environmental conditions, so must be made under the same conditions in which the error occurred. - If the value measured is lower than 1 megaohm, a check must be carried out by a technician/installer on the photovoltaic generator to identify and eliminate the problem. - If the value measured is higher than 1 megaohm and the error signal persists, contact customer assistance.
E046 - String self test fail - ⊗ No LED	Error during the automatic check of the string voltages (only in models with the "fuse-control" board): In some inverter models it is possible to carry out the check test of the polarity of the strings connected to the input (e.g.:TRIO-20.0/27.6kW). This error signal occurs when, during the test stage, an inverted string is recorded	<ul style="list-style-type: none"> • Section the inverter and check the polarity of the string(s) which the inverter has recorded as inverted. - Once all the strings have been correctly connected, activate the system once again; the inverter will once again check the correct polarity of the string inputs at the end of which it will carry out the checks for the grid connection. - If the problem (once the inverter has been switched off and back on) persists, contact customer assistance.
E049 - AC FF Error - ● Yellow LED	Error in the "AC feed-forward" circuit: Error inside the inverter	<ul style="list-style-type: none"> • Error inside the inverter and cannot be checked externally. - If the problem (once the inverter has been switched off and back on) persists, contact customer assistance.

- Code on display - Error message - Signal	Name of Alarm and Cause	Solution
E056 - Over Temp. (from external box) - ● Yellow LED	Excessive temperature measured inside the inverter's wiring box: High internal temperature. This error relates to the temperature measured on external boxes (e.g.:TRIO-20.0/27.6kW).	<ul style="list-style-type: none"> • Check that the inverter is not exposed to direct sunlight. Wait for the temperatures to which the inverter is exposed to return to the operating range and for the inverter to cool down. - If the problem (once the ambient temperature has returned to the range) persists, contact customer assistance. Remember to wait the time needed to allow the inverter to cool down
E057 - Vbulk reading error - ● Yellow LED	Input voltage (Vin) higher than booster voltage (Vbulk): The error occurs if the input voltage exceeds the Bulk voltage (voltage on the DC-DC circuit inside the inverter)	<ul style="list-style-type: none"> • It is necessary to measure the input voltage inside the inverter with a voltmeter. - If it is higher than the maximum voltage of the operating range, the alarm is genuine and it is necessary to check the configuration of the PV generator. If the voltage has also exceeded the maximum input threshold the inverter could be damaged. - If it is lower than the maximum voltage of the operating range, the alarm is caused by an internal malfunction and it is necessary to contact customer assistance.
E058 - Pin vs Pout check error - ● Yellow LED	Error in the check of Pin vs Pout: The error occurs if the difference between the measured value of input power and that of output power is greater than the limit imposed internally to the inverter.	<ul style="list-style-type: none"> • Error inside the inverter and cannot be checked externally. - If the problem (once the inverter has been switched off and back on) persists, contact customer assistance.

Power limitation messages

The equipment can signal possible output power limitations which may occur on the basis of:





- settings made by the user
- settings required by the grid standard of the country of installation
- protective devices inside the inverter

The notices of messages are shown on the highlighted part **b10** of the display ⁽²³⁾.

The following table gives the complete list of power limitation messages relating to string inverters. Some messages may not be used depending on the inverter model installed.

- Message on display - Signal	Name of Derating and Cause	Solution
- LIMxxx% CODE:00 - ▲ Display symbol b6	Power limitation: The message indicates that the user has set an output power limitation for the inverter. LIM xxx% = Power reduction percentage Examples: LIM 100% = no power limitation LIM 50% = limitation to 50% of the output nominal power	<ul style="list-style-type: none"> • Check the limitation value set in the "Settings > Power Limitation" menu
- LIMxxx% CODE:01 - ▲ Display symbol b6	Power limitation for over-frequency: The message indicates that the user has set a power limitation due to over frequency in order to reduce the maximum output power of the inverter when the grid frequency exceeds certain limits. LIM xxx% = Power reduction percentage Examples: LIM 100% = no power limitation LIM 50% = limitation to 50% of the output nominal power	<ul style="list-style-type: none"> • Check the limitation value set in the "Settings > Service Power > OF Derating" menu
- LIMxxx% CODE:02 - ▲ Display symbol b6	Power limitation for over-voltage: The message indicates that the user has set a power limitation due to over voltage (parameter U >(10 min)) in order to reduce the maximum output power of the inverter when the reading of the average grid voltage exceeds certain limits. The sampling of readings is done every 10 minutes (U>(10min)). LIM xxx% = Power reduction percentage Examples: LIM 100% = no power limitation LIM 50% = limitation to 50% of the output nominal power	<ul style="list-style-type: none"> • Check the limitation value set in the "Settings > Service Power > U > (10 min) Der." menu



- Message on display - Signal	Name of Derating and Cause	Solution
- LIMxxx% CODE:03 -  Display symbol <u>b6</u>	Anti-islanding power limitation: The message indicates that a power limitation is active since an "islanding" condition has been recorded. LIM xxx% = Power reduction percentage Examples: LIM 100% = no power limitation LIM 50% = limitation to 50% of the output nominal power	<ul style="list-style-type: none"> • If the inverter remains connected to the grid and the limitation is active, contact customer assistance
- LIMxxx% CODE:04 -  Display symbol <u>b6</u>	Power limitation due to low grid voltage: The message indicates that an output power limitation may occur since a low grid voltage (AC) condition has been recorded. LIM xxx% = Power reduction percentage Examples: LIM 100% = no power limitation LIM 50% = limitation to 50% of the output nominal power	<ul style="list-style-type: none"> • Check that the grid voltage is lower than the minimal voltage. Should this condition persist, contact the grid operator to resolve the problem.
- LIMxxx% CODE:05 -  Display symbol <u>b7</u>	Power limitation due to excess temperature: The message indicates that a power limitation is active since an excess temperature condition has been recorded inside the inverter (This parameter depends also on the power which the inverter must provide since the measurement of temperatures is taken internally and is influenced by the heat dissipated by the components of the inverter itself). LIM xxx% = Power reduction percentage Examples: LIM 100% = no power limitation LIM 50% = limitation to 50% of the output nominal power	<ul style="list-style-type: none"> • Check that the inverter is not exposed to direct sunlight. Wait for the temperatures to which the inverter is exposed to return to the operating range and for the inverter to cool down. - If the problem (once the ambient temperature has returned within the range) persists, contact customer assistance.
- LIMxxx% CODE:06 -  Display symbol <u>b6</u>	Power limitation for input over-voltage: The message indicates that a power limitation is active since an input over voltage (AC) has been recorded. LIM xxx% = Power reduction percentage Examples: LIM 100% = no power limitation LIM 50% = limitation to 50% of the output nominal power	<ul style="list-style-type: none"> • It is necessary to measure the input voltage inside the inverter with a voltmeter. - If it is higher than the maximum voltage of the operating range, the alarm is genuine and it is necessary to check the configuration of the PV generator. If the voltage has also exceeded the maximum input threshold the inverter could be damaged. - If it is lower than the maximum voltage of the operating range, the alarm is caused by an internal malfunction and it is necessary to contact customer assistance.



Dismantling the inverter

The inverter is composed of an **Inverter** part and a **Wiring Box** which may be dismantled separately. The paragraphs that follow describe dismantling procedures.

Perform the steps for "Turning off the inverter" before dismantling one or both inverter parts.

Dismantling the inverter

Procedure for dismantling the inverter part only:

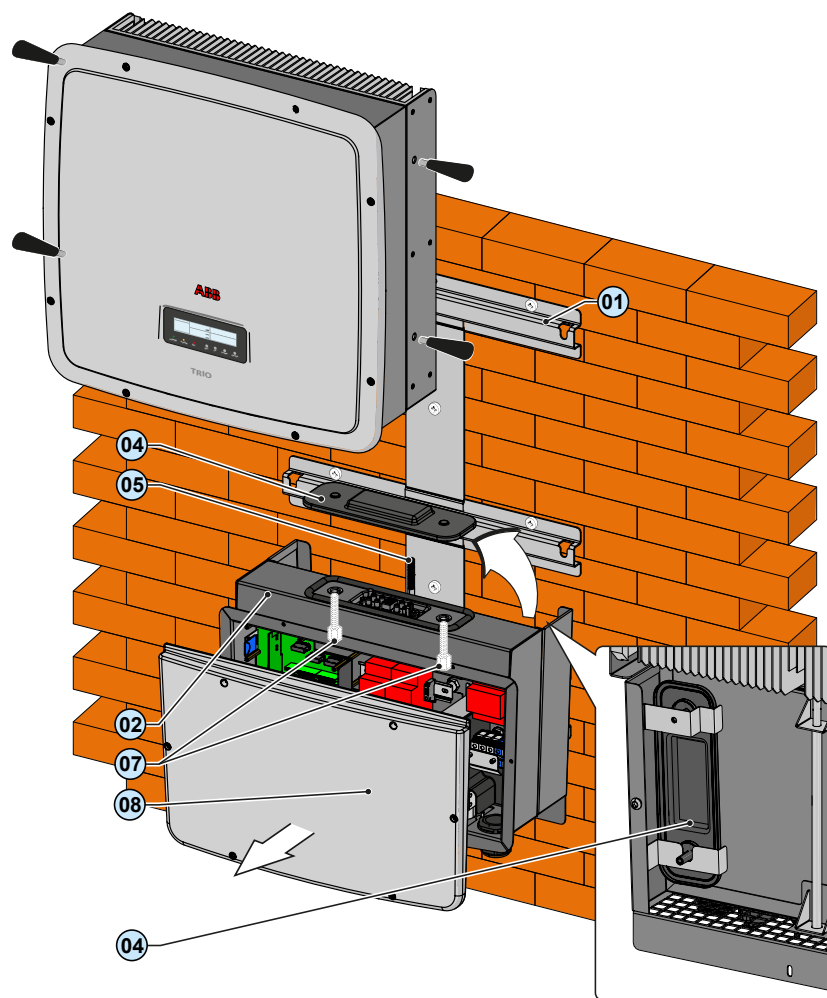

- Slacken the 6 screws holding the cover of the Wiring Box
- Slacken the two screws on connector ⑦ inside the Wiring Box
- Slacken the lock screw ⑲ on the underside
- Separate the two parts, unscrewing the screw holding them together ⑤
- Lift and remove the inverter part, releasing it from the bracket
- If the Wiring Box is to remain installed on the bracket separately from the inverter part, install the cap ④ to protect the coupling connector.
- Put the Wiring Box cover back in place and tighten the 6 screws holding it in place



Dismantling the Wiring Box

Procedure for dismantling the Wiring Box only:

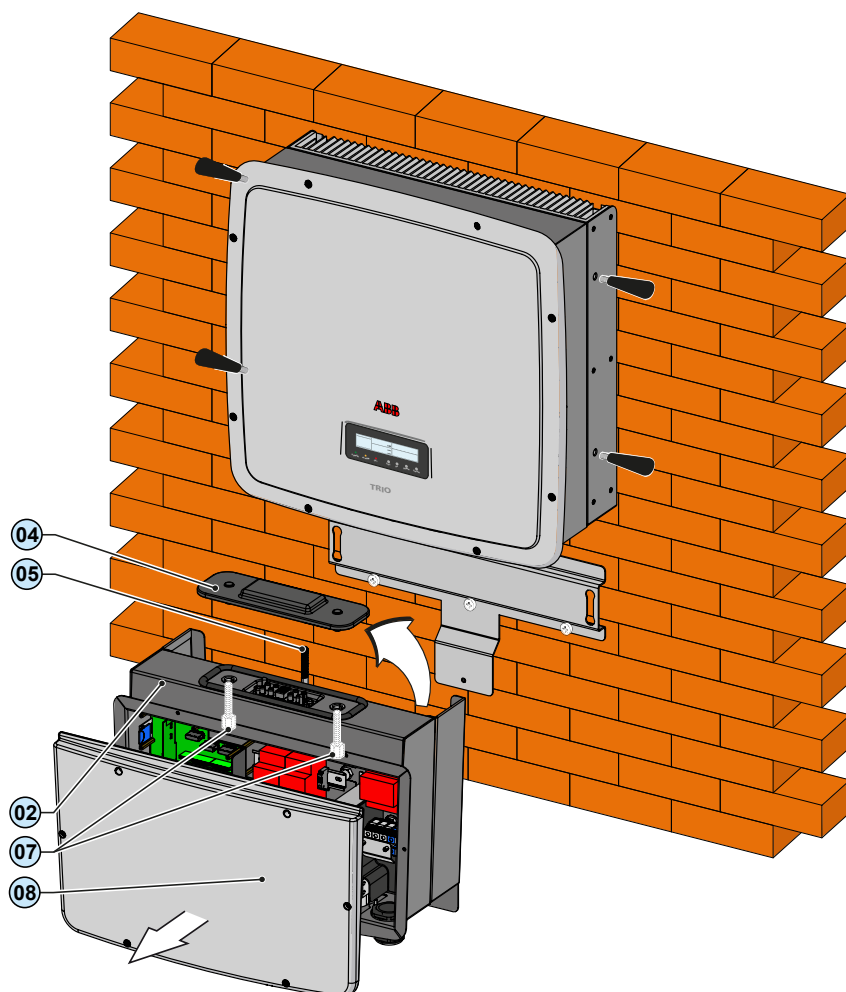

- Slacken the 6 screws holding the cover of the Wiring Box
- Remove all connecting cables coming from outside the box.
- Slacken the two screws on connector ⑦ inside the Wiring Box
- Slacken the lock screw ②7 on the underside
- Separate the two parts, unscrewing the screw holding them together ⑤
- Remove the Wiring Box, detaching it from the bracket
- Put the Wiring Box cover back in place and tighten the 6 screws

Registration on “Registration” website and calculation of second-level password (Service Menu)

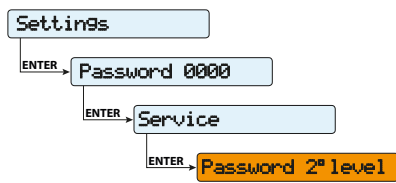

In order to obtain the second-level password needed to access the inverter's service menu, it is necessary to go through the following stages:

Stage 1 - Collection of information relating to the inverter.

Collect the following information relating to each inverter for which you wish to have a password:

- **S/N** - Serial number of the inverter. This information can be found on the label giving the identity details of the inverter or on the display by accessing the “INFORMATION” menu → Serial No.”

The serial number consists of 6 digits (the last 6 in models with a label giving a 10-digit S/N)

- **WK** - Production week. This information can be found on the label giving the identity details of the inverter or on the display by accessing the “INFORMATION” menu → Serial No.”

The production week consists of 4 figures, indicating the week (first 2 digits) and the year of production (last 2 digits)

- **Update Version** - This information is available only for some inverter models and can be found on the display by accessing the menu “INFORMATION → Firmware”.

Stage 2 - Registration on <https://registration.ABBSolarinverters.com>

- Go online and access <https://registration.ABBSolarinverters.com>

- Set the desired language and click on the specific icon to start registration

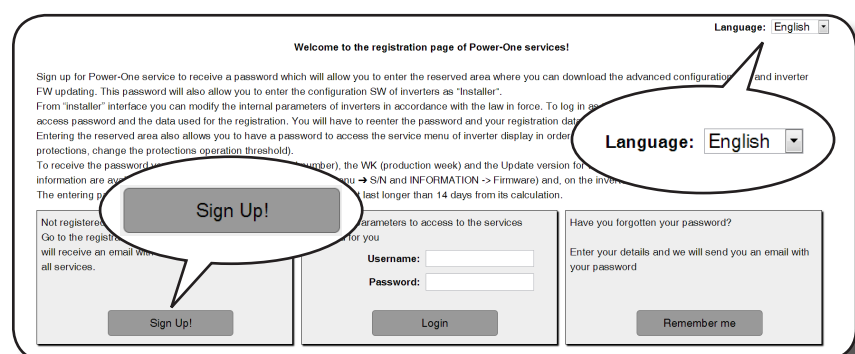

- Insert the personal data requested and end the registration stage

- An email will be sent to the email address used with a link to complete the registration process.

- Once the registration process is over, a further email will be sent with the password to access the website.

The password obtained enables access also to the advanced “Installer” mode present on the configuration software for inverters. The configuration software can be downloaded in a specific section of the website <https://registration.ABBSolarinverters.com>



Stage 3 - Request for second level password

- Go online and access <https://registration.ABBSolarInverters.com>
- Insert the Username (corresponding to the email used during registration) and the Password obtained at the end of Stage 2

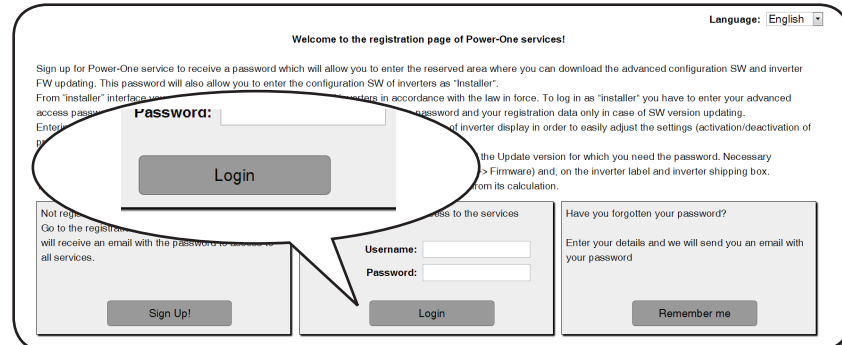

- Access the section dedicated to requesting the second-level password

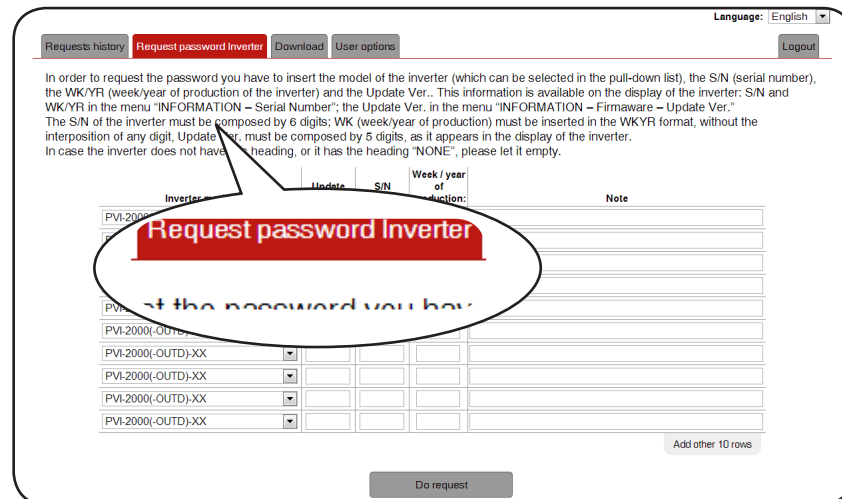

- Choose the inverter model from the drop-down list and insert Update Ver., Serial Number and Week of Production of the inverter which were obtained previously (Stage 1)

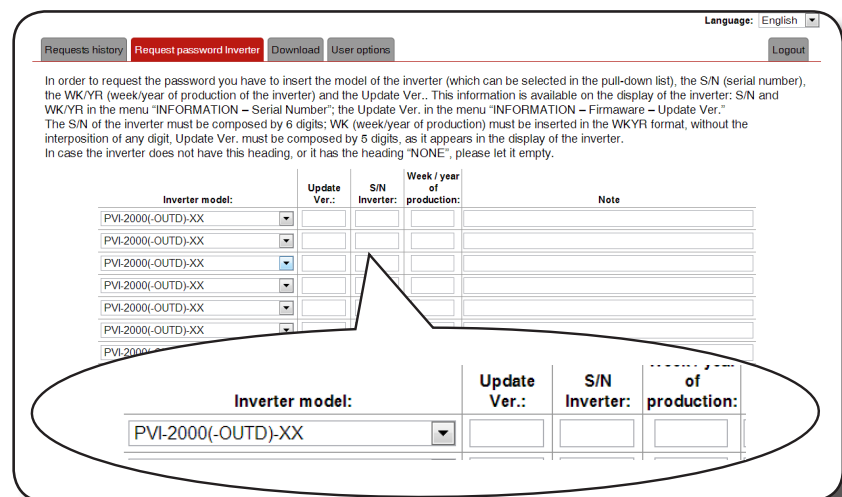

- Click on icon to request password.

Language: English

Requests history | Request password Inverter | Download | User options | Logout

In order to request the password you have to insert the model of the inverter (which can be selected in the pull-down list), the S/N (serial number), the WK/YR (week/year of production of the inverter) and the Update Ver.. This information is available on the display of the inverter: S/N and WK/YR in the menu "INFORMATION – Serial Number"; the Update Ver. in the menu "INFORMATION – Firmware – Update Ver."
The S/N of the inverter must be composed by 6 digits; WK (week/year of production) must be inserted in the WKYR format, without the interposition of any digit, Update Ver. must be composed by 5 digits, as it appears in the display of the inverter.
In case the inverter does not have this heading, or it has the heading "NONE", please let it empty.

Inverter model:	Update Ver.:	S/N Inverter:	Week / year of production:	Note
UNO-2.0-I-OUTD	12345	123456	0513	
PVI-3.0-OUTD-XX		987654	0412	
TRIO-27.6-TL-OUTD	13052	564789	4812	
PVI-2000(-OUTD)-XX				
PVI-2000(-OUTD)-XX				
PVI-2000(-OUTD)-XX				
PVI-2000(-OUTD)-XX				
PVI-2000(-OUTD)-XX				
PVI-2000(-OUTD)-XX				
PVI-2000(-OUTD)-XX				

Do request

Add other 10 rows

Do request

Should there be an error in inputting data, the fields containing the error will be highlighted in red. If, on the other hand, the data are correct, the passwords will be shown in a new window and at the same time sent to the email address used for registration.



The second-level password enables access to the service menu which allows the inverter's sensitive parameters to be changed. Proceed to changing the aforementioned parameters only when requested by the grid operator or by customer assistance.



Resetting the time remaining to change the grid standard

From the time a valid grid standard is entered and the inverter is turned on, a period of 24 hours is available to modify the grid standard setting.



The 24 hours are counted only when the inverter is turned on.

Check that the date and time are set correctly. Otherwise it may not be possible to access the "Service" menu to reset the timer.

After this period of time the system will block changes to the standard; and it will be necessary to carry out the following procedure to reset the remaining time and obtain another 24 hours to select a new grid standard:

Settings

1. Access the "SETTINGS" menu by entering the first-level password (default 0000)

Service

2. Access the "Service" sub-menu by entering the second-level password



The password to access the "Service" menu can be obtained by registering at the site <https://registration.ABBSolarinverters.com>

Before accessing the site it will be necessary to locate the information utilized to compute the password:

Inverter model

Serial number and week of manufacture

Update field

The "Update" field is available only if the firmware of the inverter has been previously updated. If not available leave the field blank when requesting the password

The password obtained is valid for a period of 15 days

Reset Country S.

3. Select "Reset Country S." to reset the 24 hours of operation in which the grid standard may be modified..



Associating a “new component” after replacement

NEW SYSTEM PART
REFUSED!

The two parts that comprise the equipment (inverter and wiring box) are logically associated with one another. When the parts are dissociated from one another due to the wiring box or inverter being replaced (perhaps because of a failure, etc.), a message is displayed to indicate that the new component must be associated with the original part.

The association of the parts comprising the inverter is carried out as follows:

Settings

1. Access the “SETTINGS” menu by entering the first-level password (default 0000)

Time

2. Set the date and time in the “Date/Time” sub-menu

Service

3. Access the “Service” sub-menu by entering the second-level password



The password to access the “Service” menu can be obtained by registering at the site <https://registration.ABBSolarinverters.com>

Before accessing the site it will be necessary to locate the information utilized to compute the password:

Inverter model

Serial number and week of manufacture

Update field

The “Update” field is available only if the firmware of the inverter has been previously updated. If not available leave the field blank when requesting the password

The password obtained is valid for a period of 15 days.



Accept Boards

4. Select “Accept Boards” to associate the two parts of the device

Once the above steps have been carried out the association of the two parts is concluded and the inverter will resume its normal operation automatically.

Replacing the string fuses (versions S2F / S2X)

Replacing the string protection fuses in inverter versions S2F/S2X may be necessary when:

1. Adjusting the fuse rating in relation to the type of PV panel utilized
2. The fuse is damaged

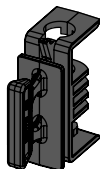

Replacing the fuse is carried out by means of the specific fuse carrier which makes it simple to extract the fuse and correctly position the new fuse when it is inserted.

String fuse replacement procedure:

1. Disconnect the strings by opening the AC+DC disconnect switch and thereafter the quick fit input connectors.



By opening the AC+DC disconnect switch alone, the DC input voltage is still present on the fuse boards.

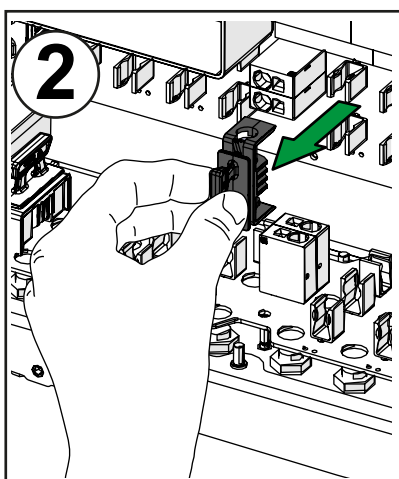

2. Remove the fuse to be replaced by grasping the fuse carrier handle

3. Raise the fuse holding clip and extract the fuse from the carrier at the same time

4. Insert the new fuse into the carrier

5. Install the fuse carrier inside the wiring box

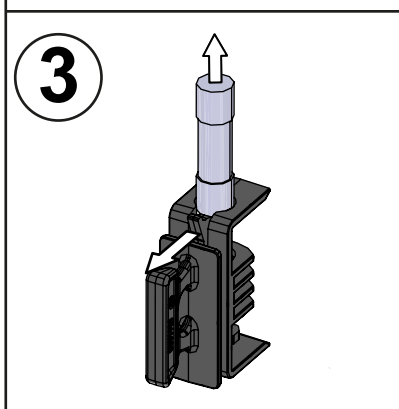

Check that the fuse carrier is flush with the fuse board once the fuse carrier is installed.

Replacing the back-up battery

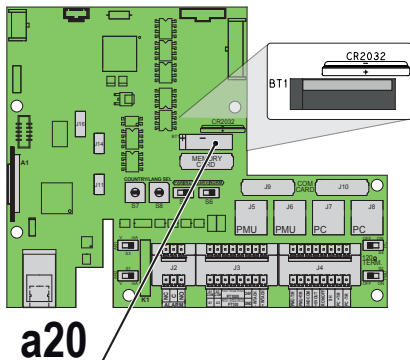

The back-up battery may need to be replaced when:

1. An error message is displayed
2. The date and time settings are reset

The battery is of the CR2032 type and is installed on the communication board, but is accessible only by removing the protective plastic cover installed over the DC high-voltage sections.

Back-up battery replacement procedure:

1. Disconnect the strings by opening the AC and DC disconnect switches external to the inverter (versions base/S2) or the AC+DC disconnect switch (versions S2F/S2X) and thereafter the quick fit input connectors.



By opening the AC+DC disconnect switch alone (versions S2F/S2X), the DC input voltage is still present on the communication board.

2. Remove the plastic cover installed over the communication board
3. Remove the battery to be replaced
4. Install the new battery taking care to handle it with insulating gloves to ensure it is not discharged and respecting the polarity displayed on the communication board silkscreen

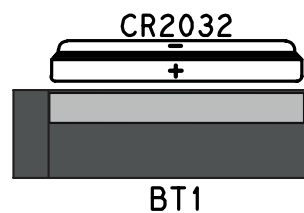
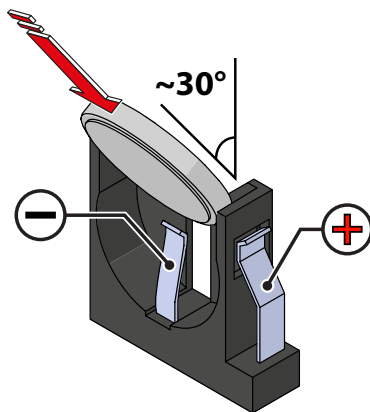

5. Replace the plastic cover over the communication board
6. Reconnect the input strings (versions S2F/S2X) and turn the inverter on

Verification of ground leakage

In the presence of anomalies or report of ground fault (where provided), there may be a ground leakage from the PV generator (DC side).

To check this, measure the voltage between the positive pole and ground and between the negative pole (of the PV generator) and ground using a voltmeter whose input accepts a voltage sufficient for the dimensions of the photovoltaic generator.

Behaviour of a system without leakage

Due to the capacitive effect of the PV generator, during the first moments that the voltmeter is connected between one of the two poles and ground, it will measure a voltage of about $V_{oc}/2$, which will tend to stabilize to around 0V if there is no ground leakage, as shown in the graph below:

The internal resistance of the voltmeter tends to zero the voltage present on the PV generator due to the capacitive effect.

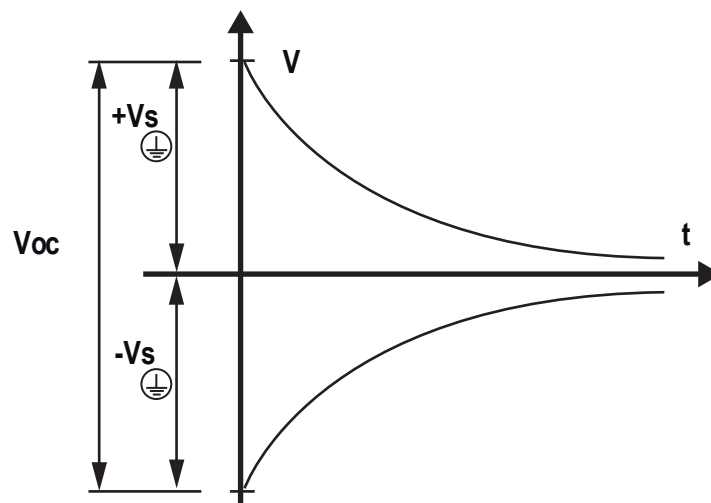

How to make the measurement:

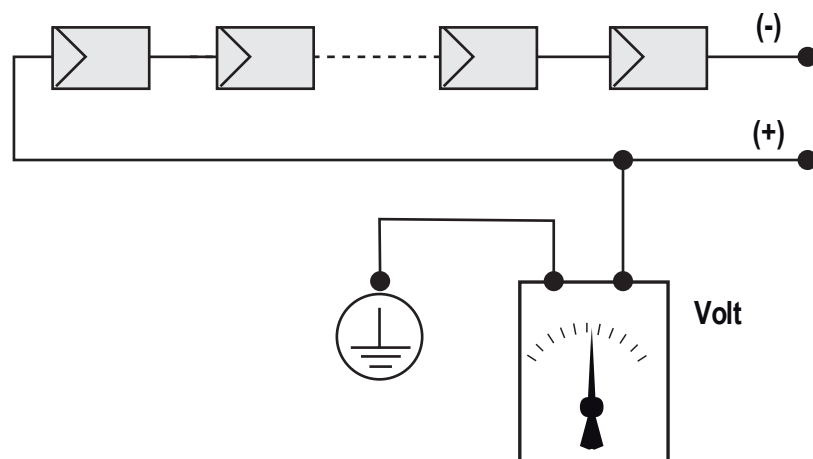

Behaviour of a system with leakage

If the voltage measured between one of the two poles and ground does not tend to 0V and stabilizes on a value, there is a ground leakage from the PV generator.

Example: When the measurement is made between positive pole and ground, a voltage of 200V is measured.

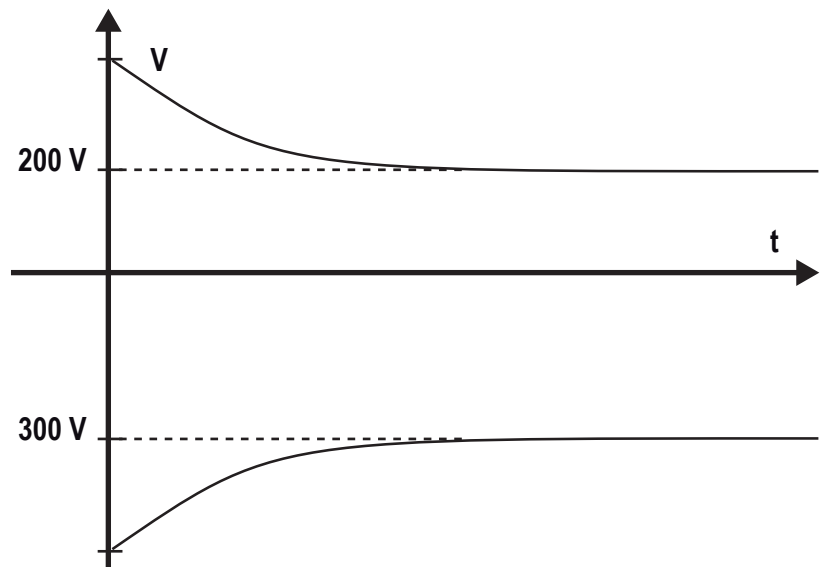

This means that if the system is made up of 10 modules in series and each one supplies 50V, the leakage can be located between the 4th and 5th PV module.

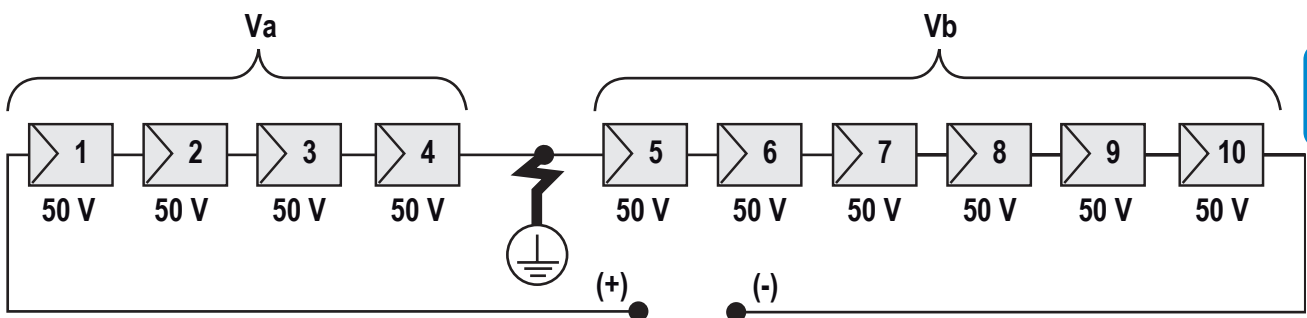

V_a = voltage measured between + pole and \oplus = 200V

V_b = voltage measured between - pole and \oplus = 300V

In all measurements with \oplus , the ground of the inverter is indicated.

Measuring the insulation resistance of photovoltaic generator

To measure the insulation resistance of the PV generator compared to ground (⊕), the two poles of the PV generator must be short-circuited (using a suitably sized switch).

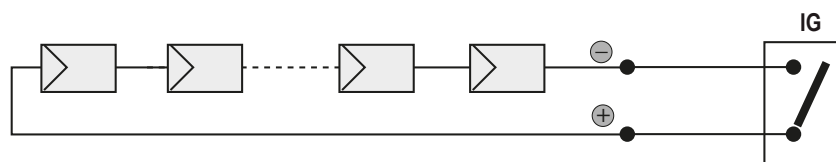

Once the short-circuit has been made, measure the insulation resistance (Riso) using a megohmmeter positioned between the two shorted poles and ground (of the inverter).

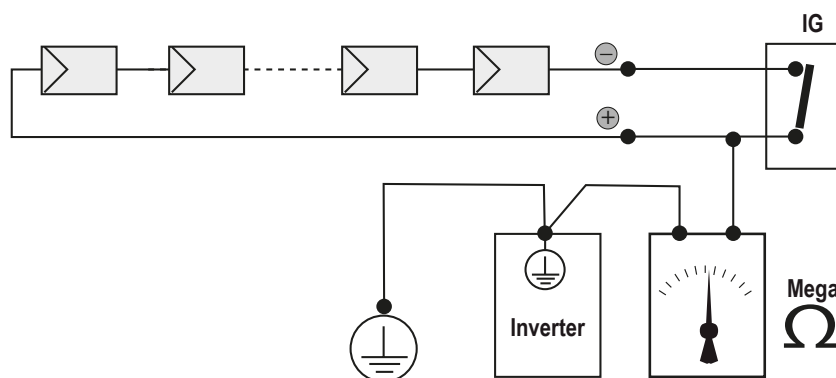

-TL MODELS (transformerless). If the measured insulation resistance (Riso) is less than 1Mohm the inverter does not connect to the grid due to a low insulation of photovoltaic generator respect to ground.

-I MODELS (with high frequency transformer). If the measured insulation resistance (Riso in case of input poles floating respect to ground or QF=1 if the one of input poles is grounded) is less than 0.2Mohm the inverter does not connect to the grid due to a low insulation of photovoltaic generator respect to ground.

The insulation resistance is affected by the environmental conditions the PV generator is in (E.g.: photovoltaic module wet from dump or rain), and therefore the measurement must be made immediately after the anomaly

Storage and dismantling

Storage of the equipment or prolonged stop

If the equipment is not used immediately or is stored for long periods, check that it is correctly packed and contact ABB for storage instructions. The equipment must be stored in well-ventilated indoor areas that do not have characteristics that might damage the components of the equipment.

Restarting after a long or prolonged stop requires a check and, in some cases, the removal of oxidation and dust that will also have settled inside the equipment if not suitably protected.

Dismantling, decommissioning and disposal

ABB CANNOT be held responsible for disposal of the equipment: displays, cables, batteries, accumulators, etc., and therefore the customer must dispose of these substances, which are potentially harmful to the environment, in accordance with the regulations in force in the country of installation.

If the equipment is dismantled, in order to dispose of the products that it is composed of, you must adhere to the regulations in force in the country of destination and in any case avoid causing any kind of pollution.

Dispose of the various types of materials that the parts of the equipment consist of in dumps that are suitable for the purpose.



Table: disposal of components

COMPONENT	MATERIAL OF CONSTRUCTION
Frame, brackets, supports	Arc-welded steel FE37
Casing or covers	ABS, plastic
Paint and	RAL
Gaskets and seals	Rubber / Teflon / Viton
Electrical cables	Copper / Rubber
Conduits	Polyethylene / Nylon
Back-up battery	Nickel / Lead/ Lithium

Further information

For more information on ABB products and services for solar applications, navigate to www.abb.com/solarinverters

Contact us

www.abb.com/solarinverters